

Figura 1



Figura 2



Figura 3

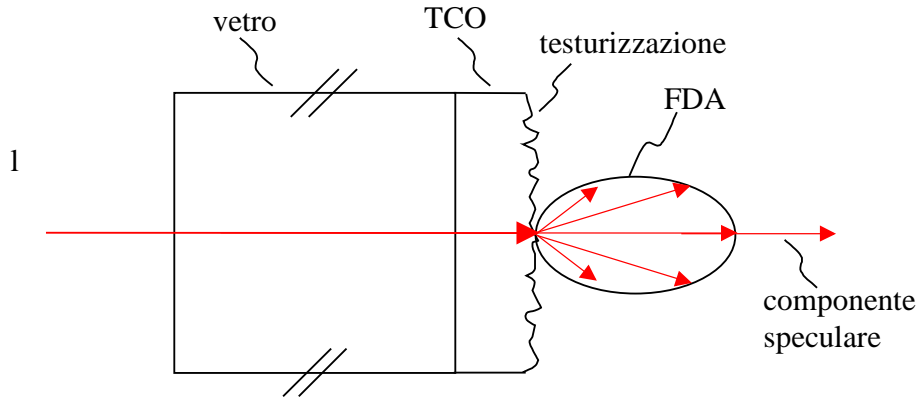

Figura 4

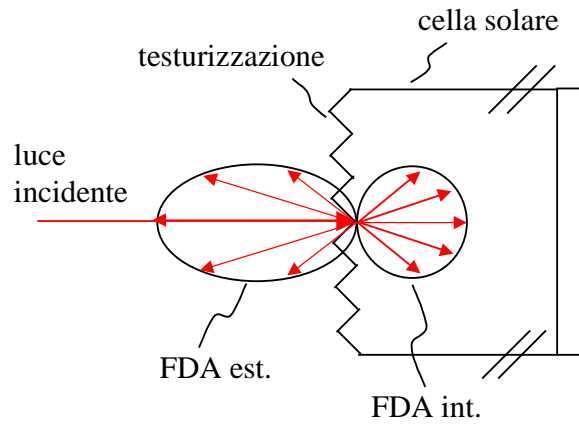

Figura 5

a)

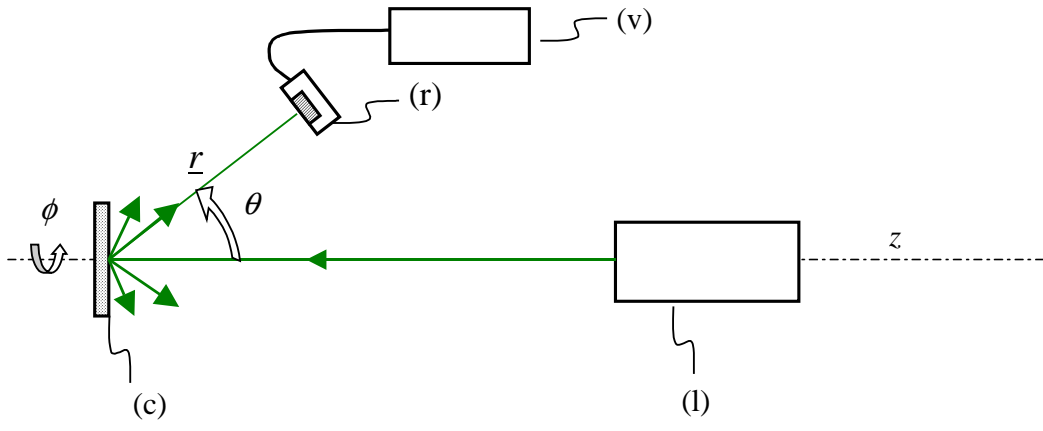

b)

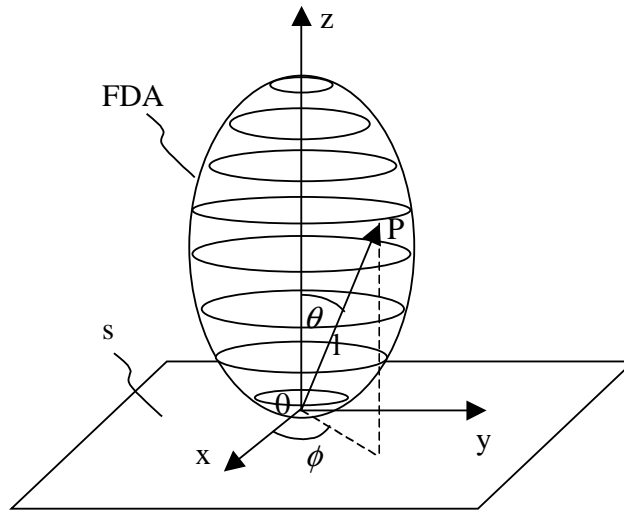
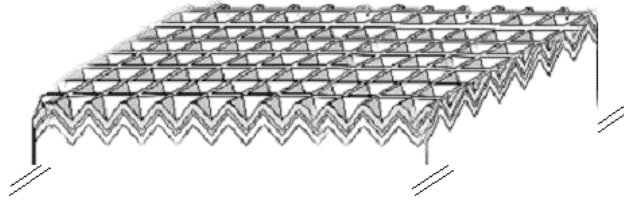

Figura 6

a)



b)

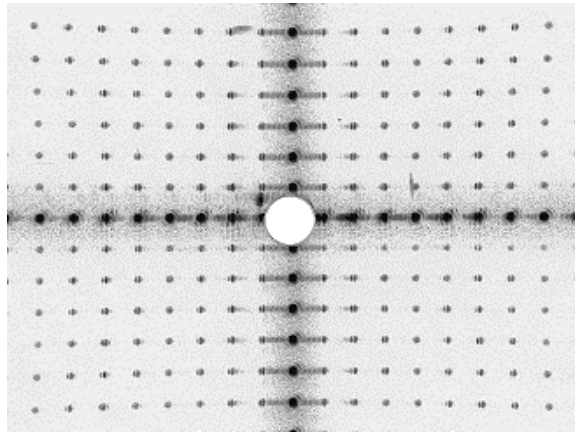
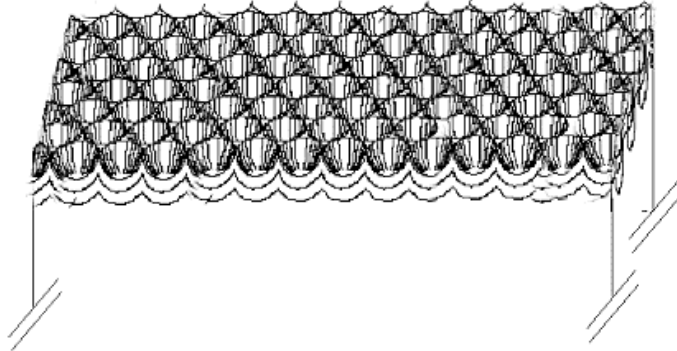

Figura 7

a)



b)

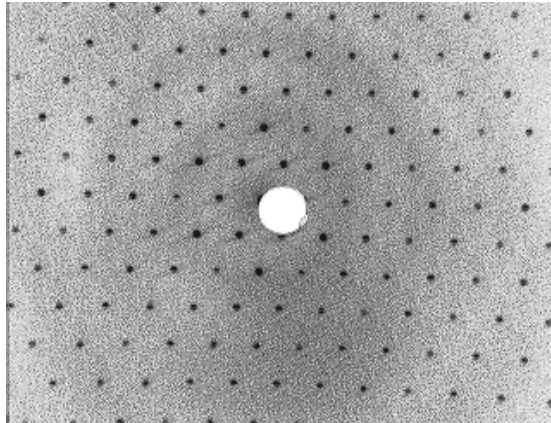
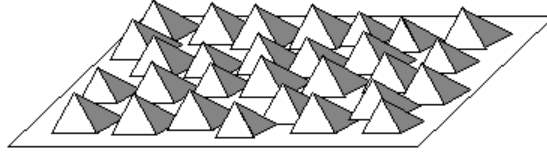

Figura 8





Figura 9

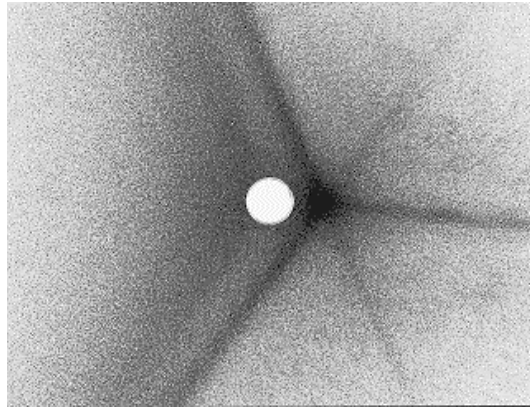

Figura 10

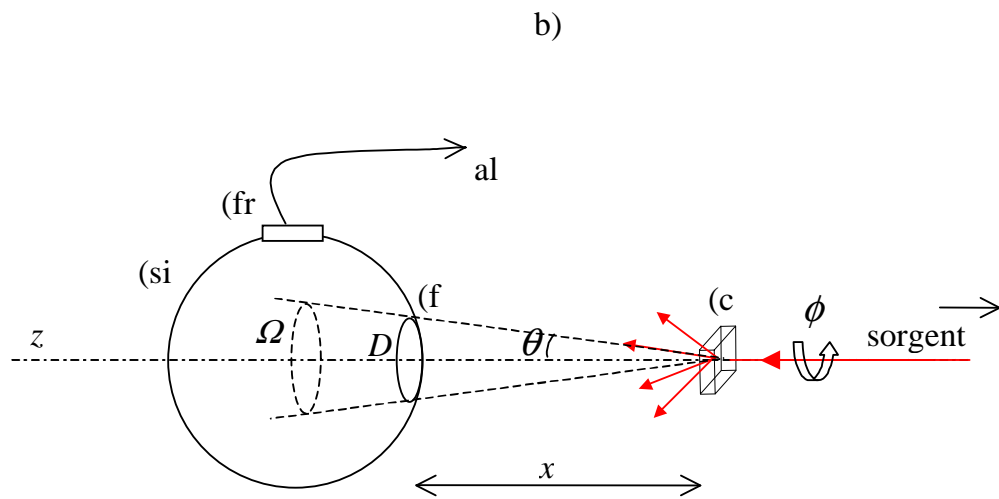
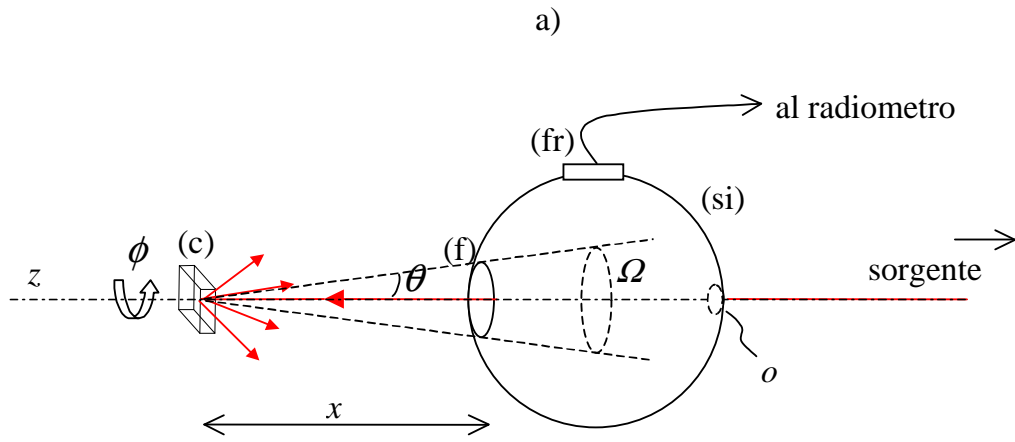

Figura 11

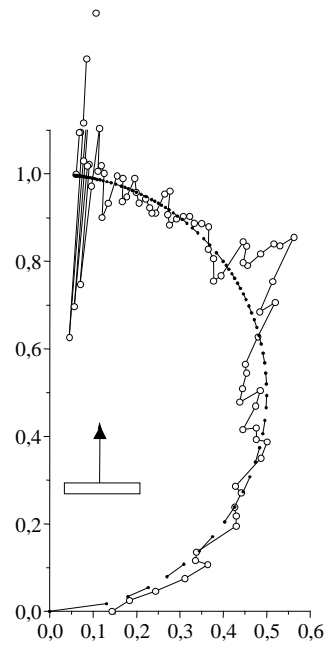

Figura 12

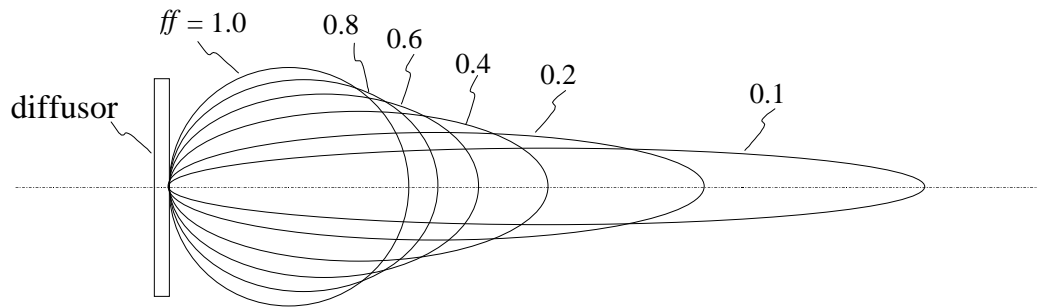

Figura 13

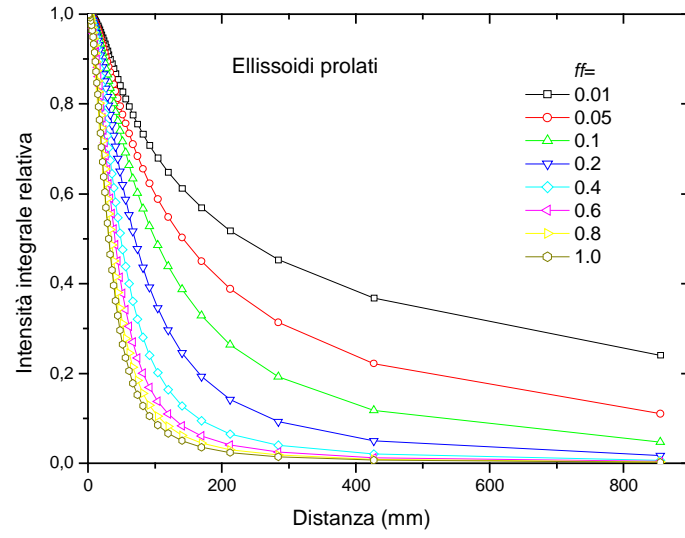

Figura 14

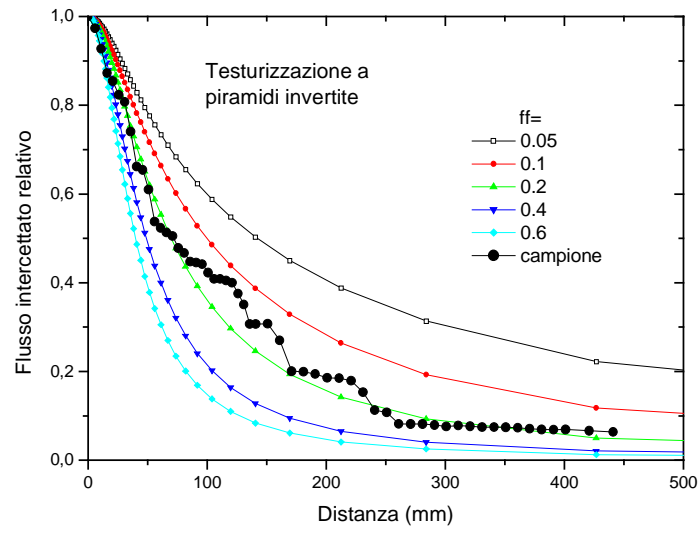

Figura 15

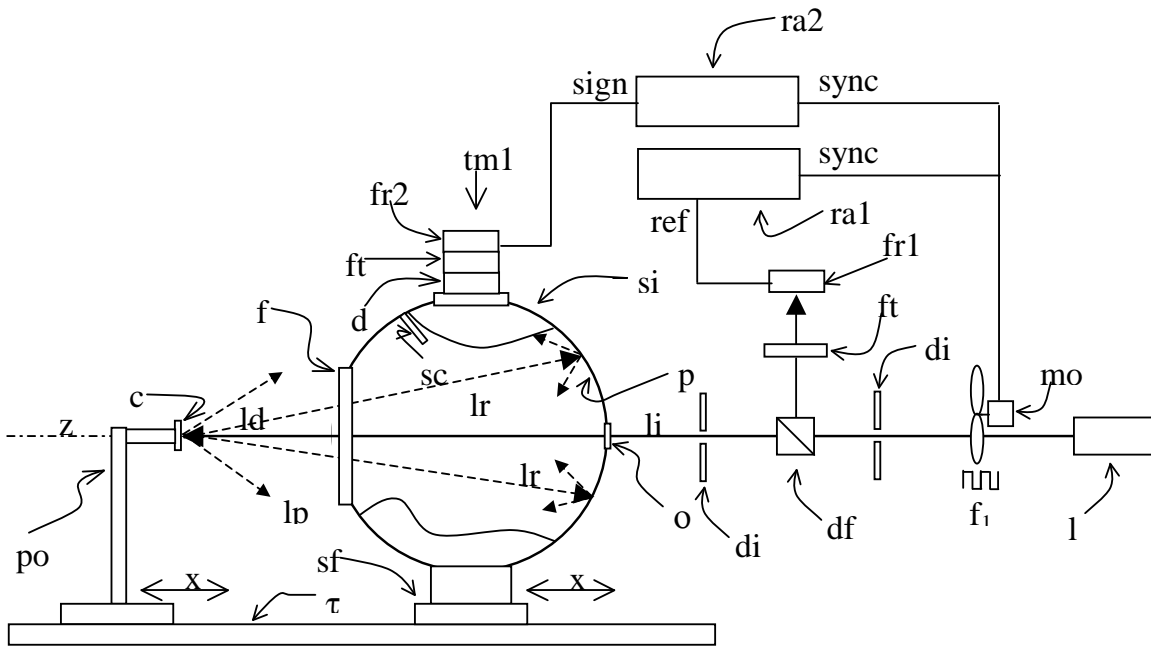

Figura 16



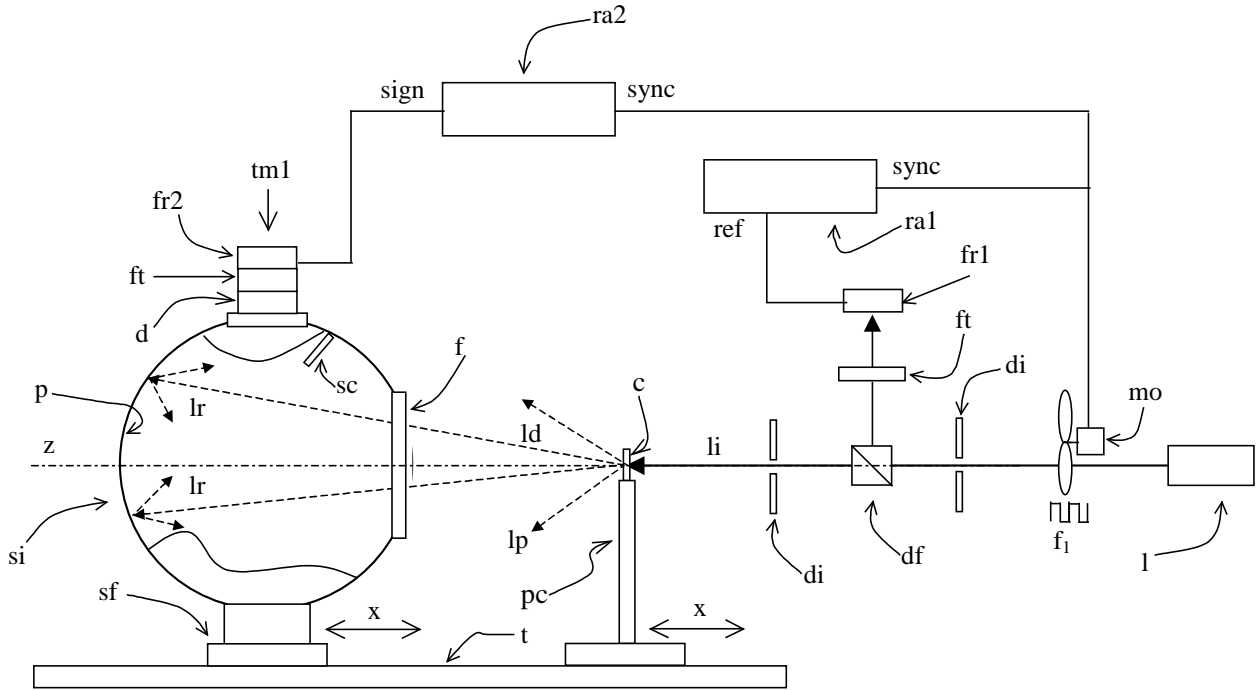

Figura 17

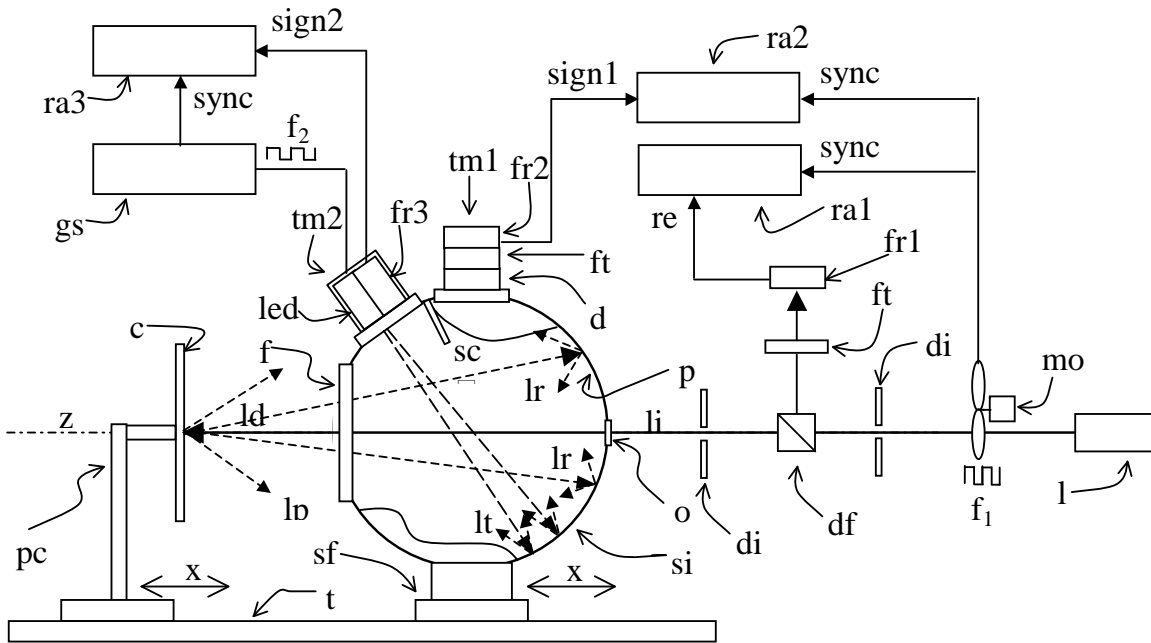

Figura 18

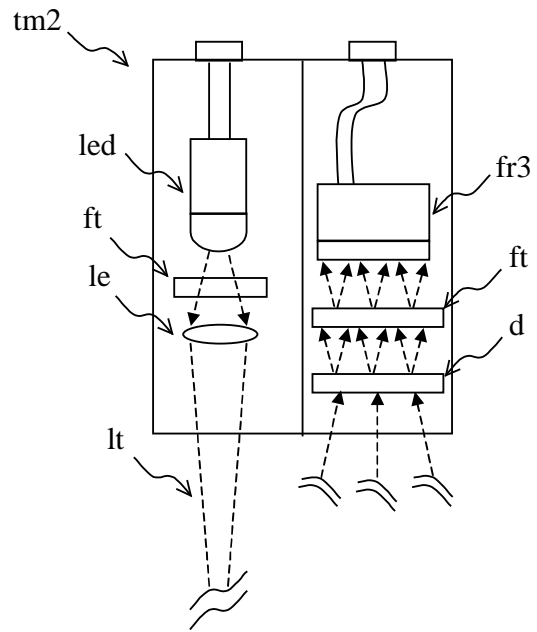

Figura 19

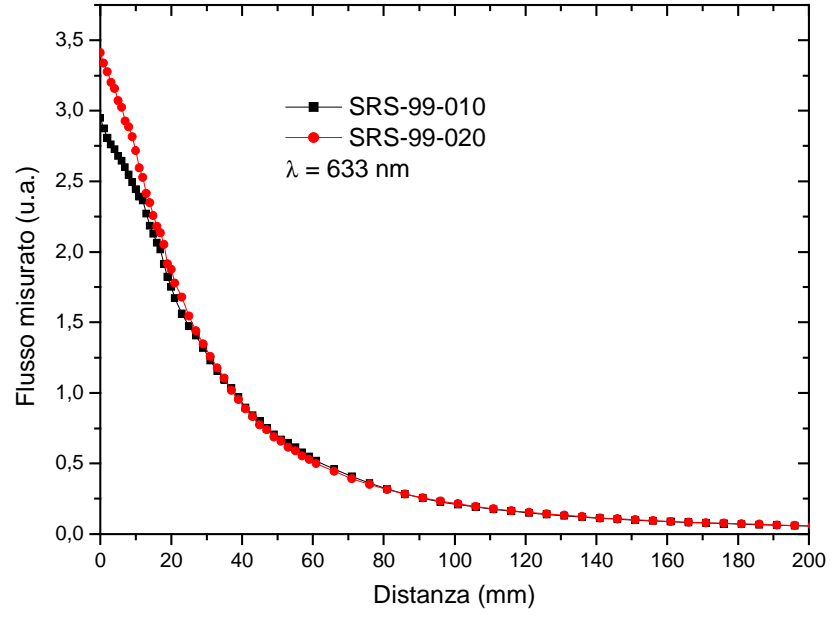

Figura 20

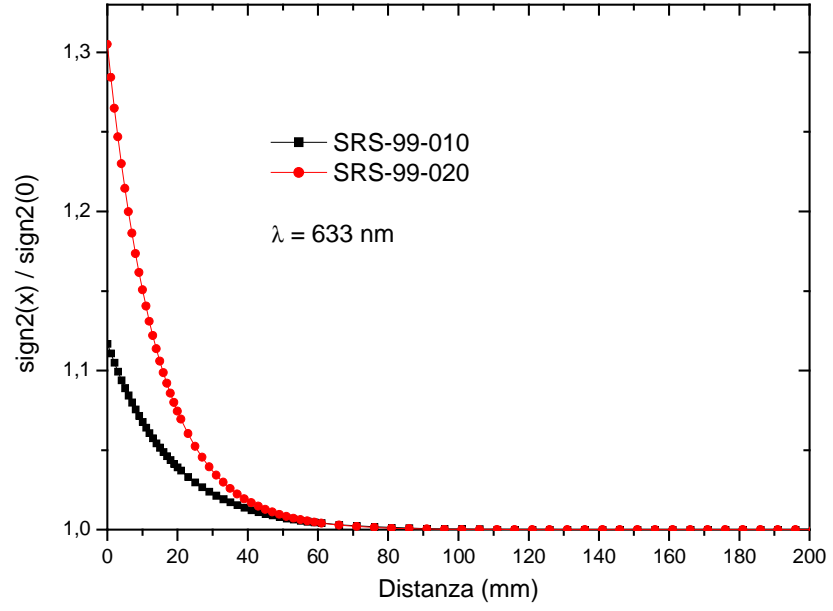

Figura 21

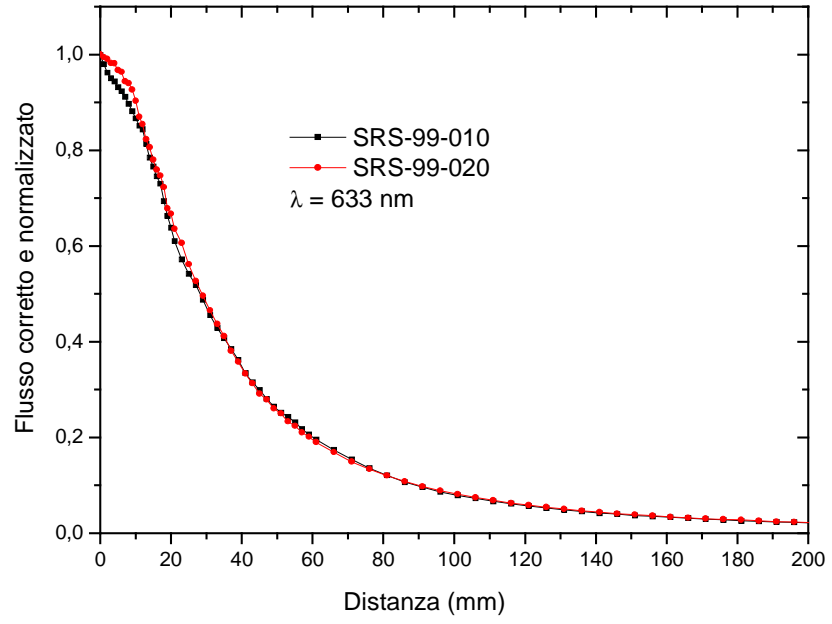

Figura 22

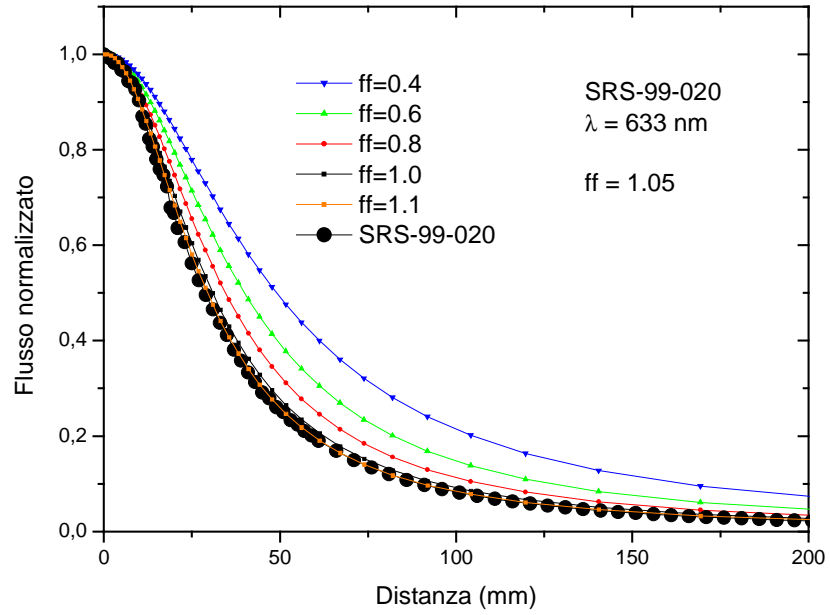

Figura 23

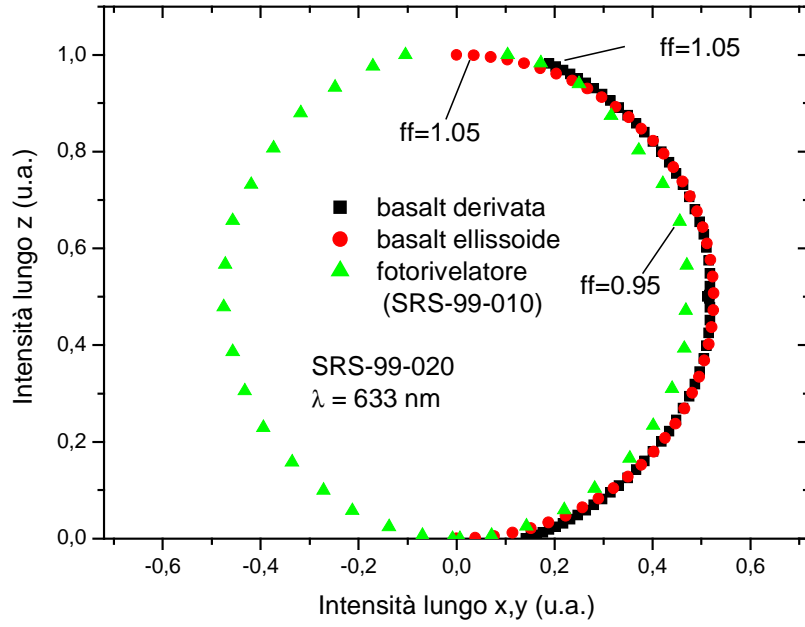

Figura 24



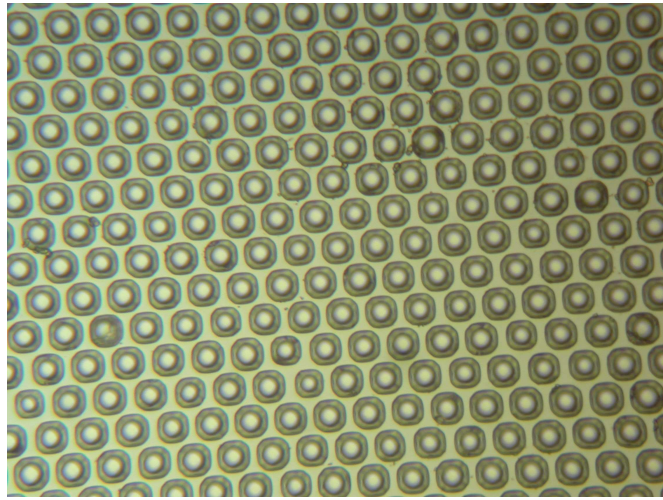

Figura 25

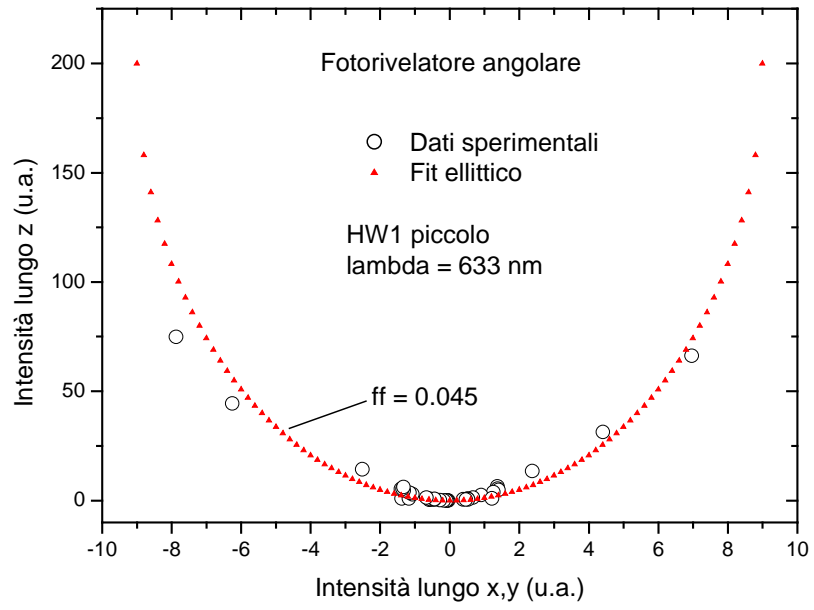

Figura 26

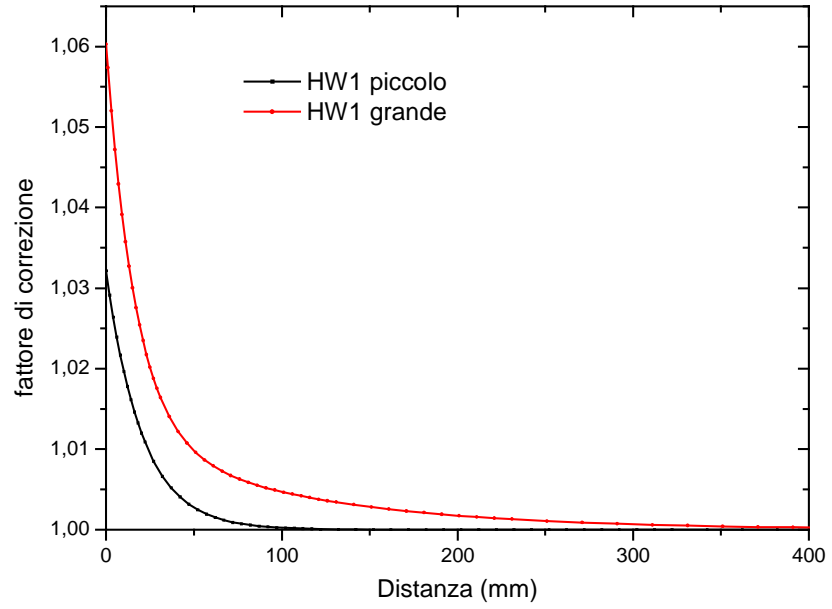

Figura 27

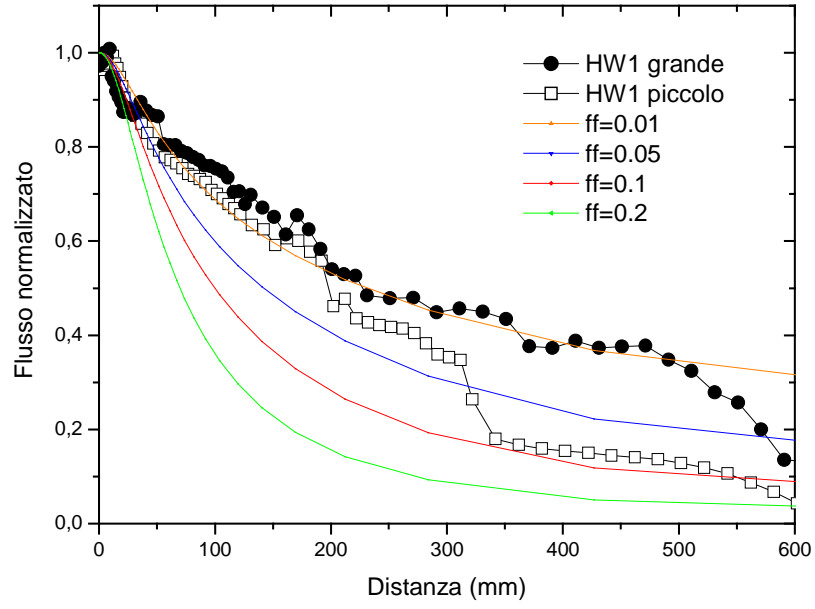

Figura 28

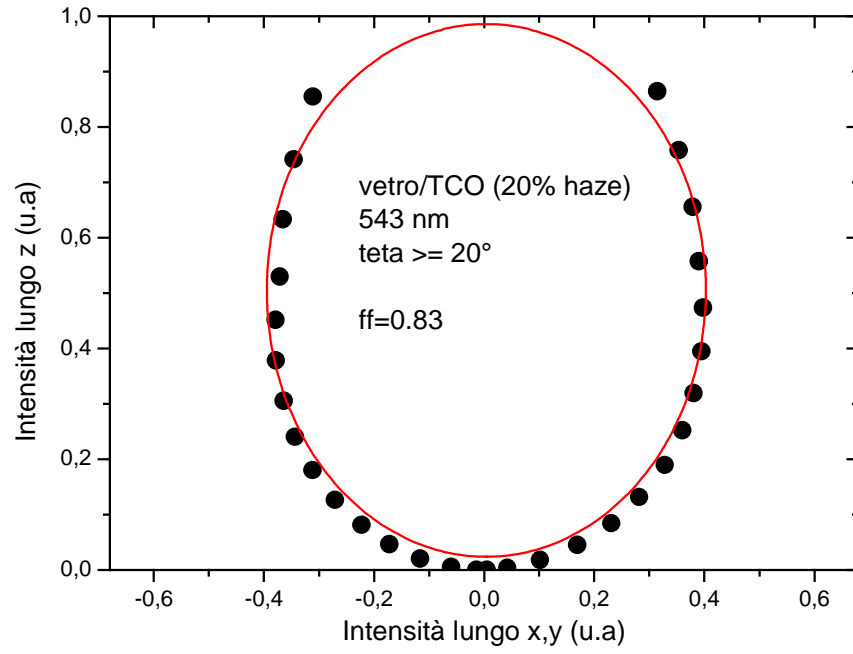

Figura 29

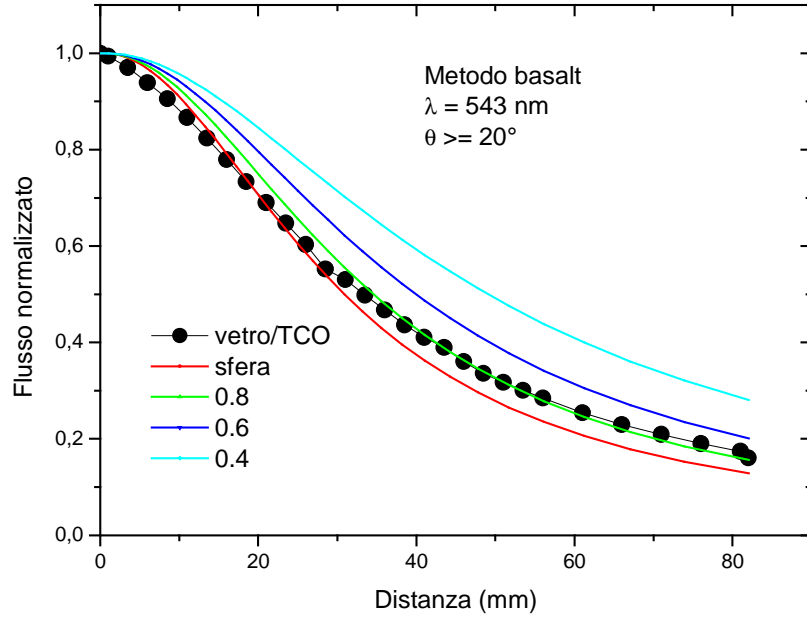

Figura 30

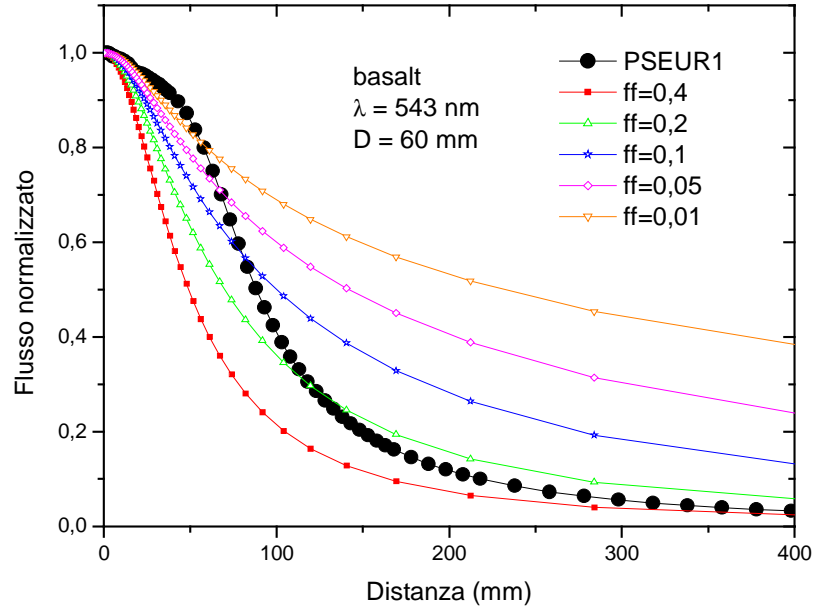

Figura 31

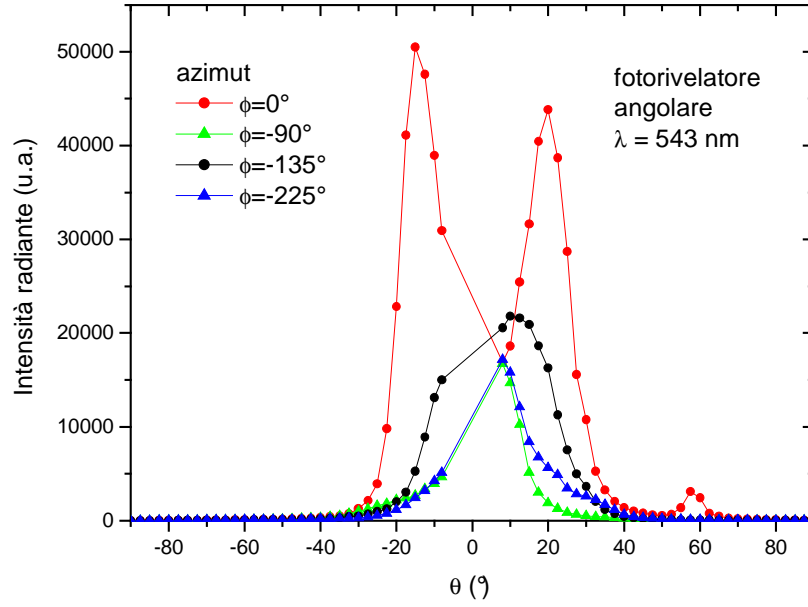

Figura 32



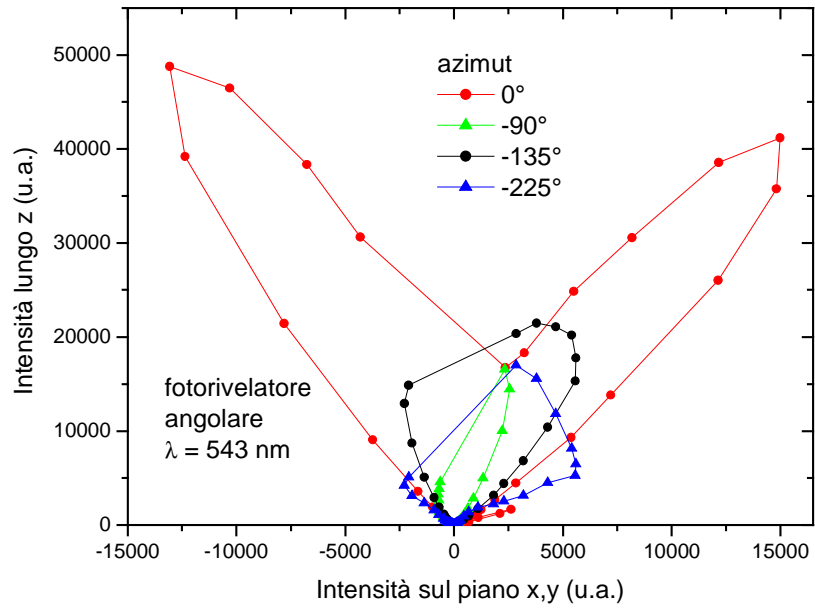

Figura 33

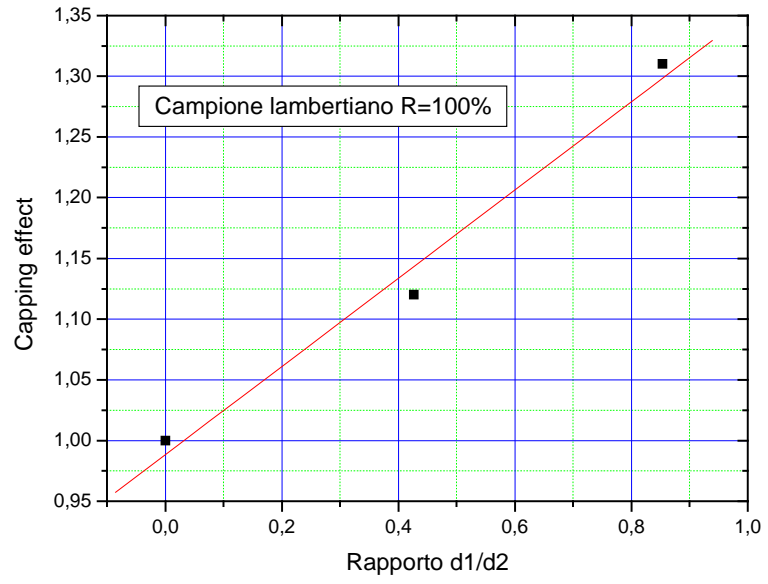

Figura 34

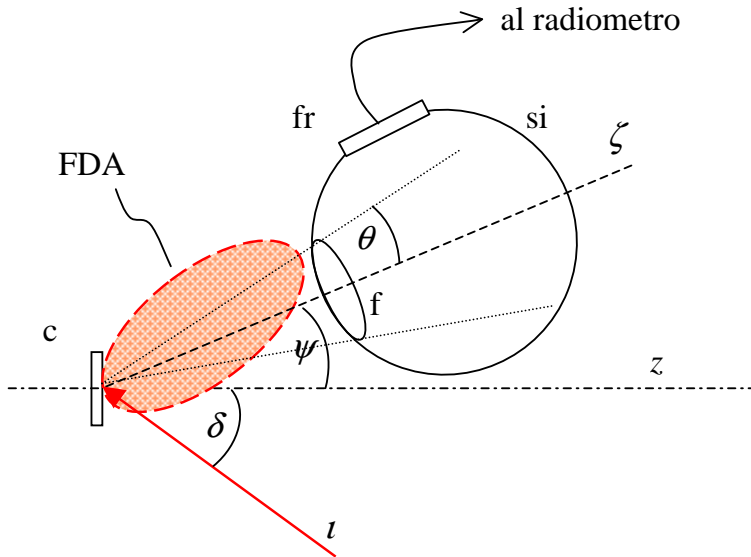

Figura 35

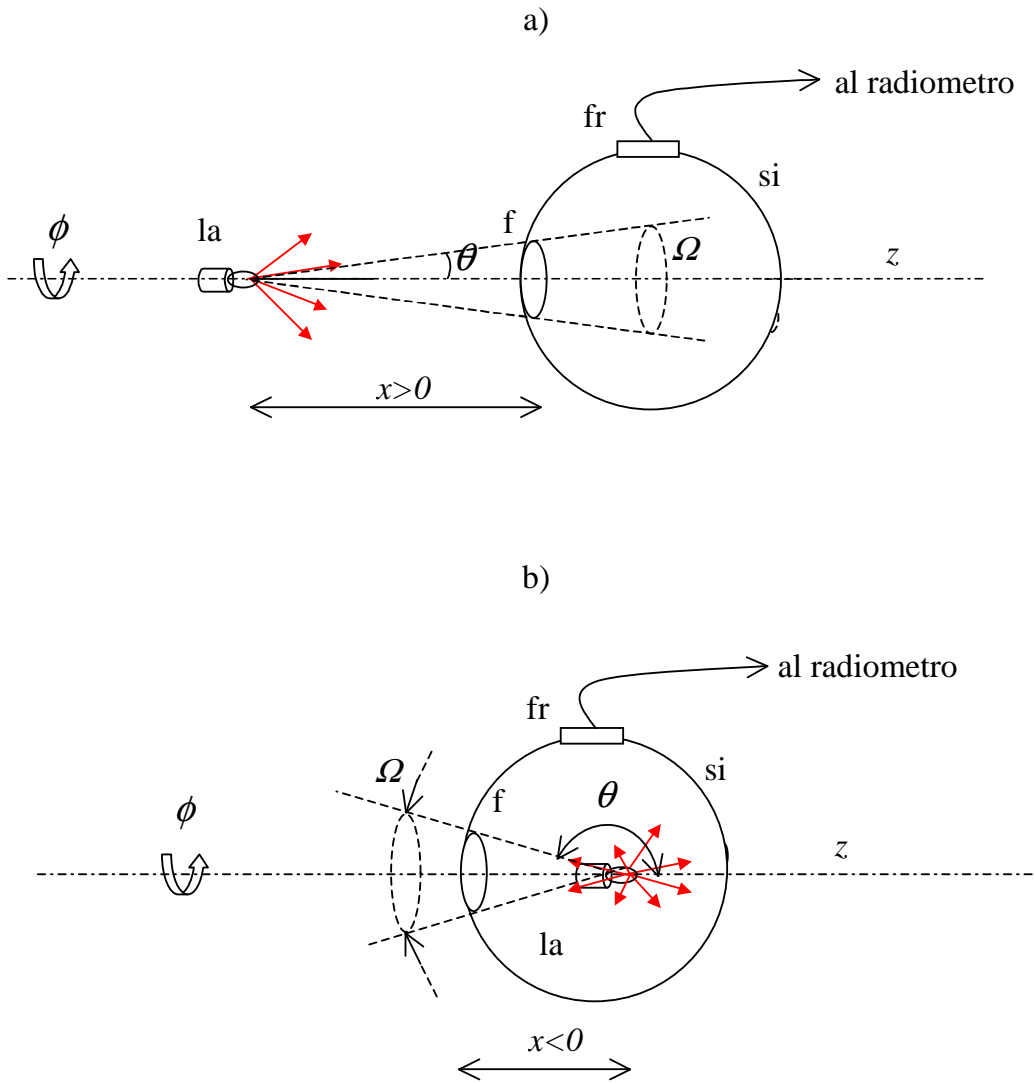

Figura 36

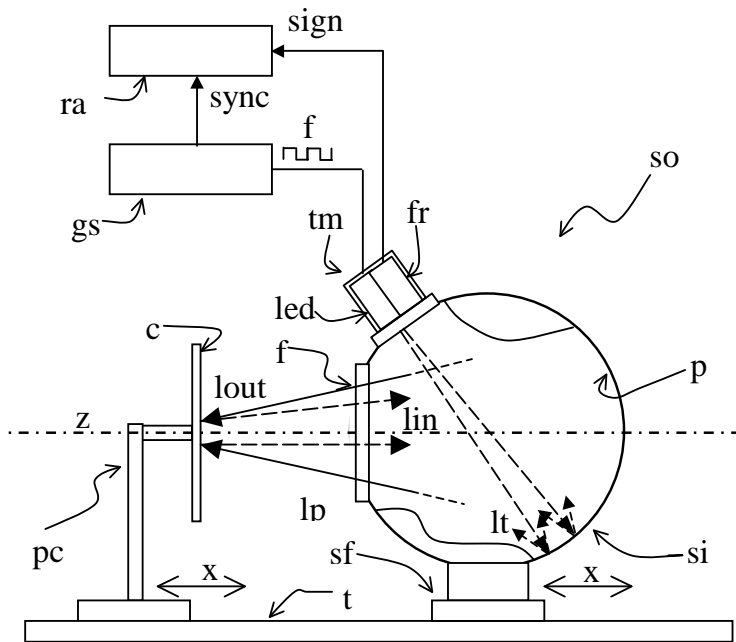
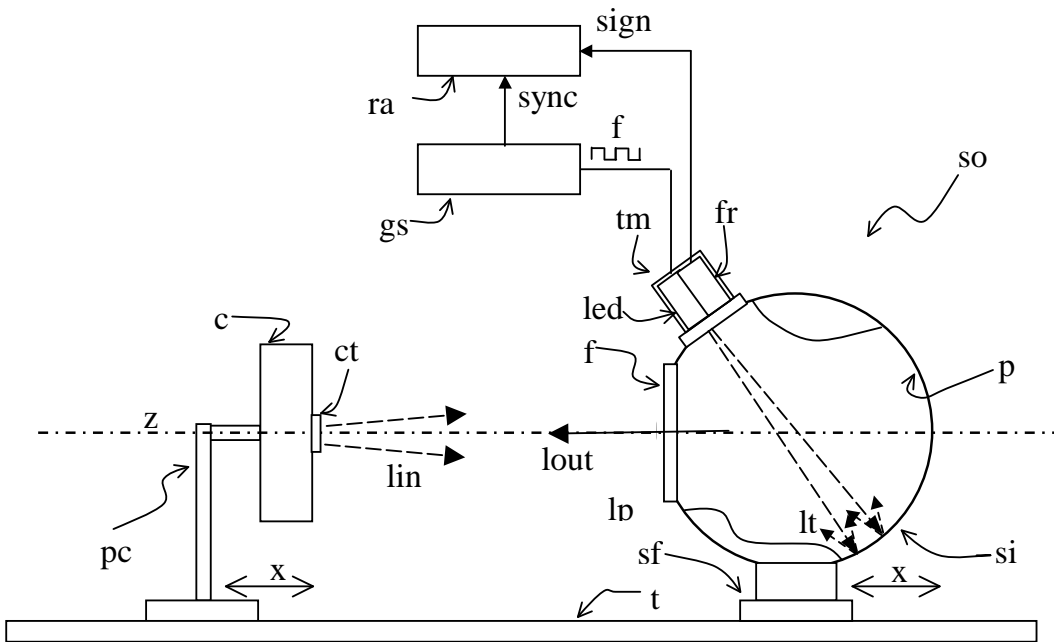