

# **SISTEMI ENERGETICI COGENERATIVI**

**La trigenerazione:  
motivazioni e tecnologie**

**Prof. Pier Ruggero Spina**

**Dipartimento di Ingegneria - Università di Ferrara**

# Il fabbisogno termico

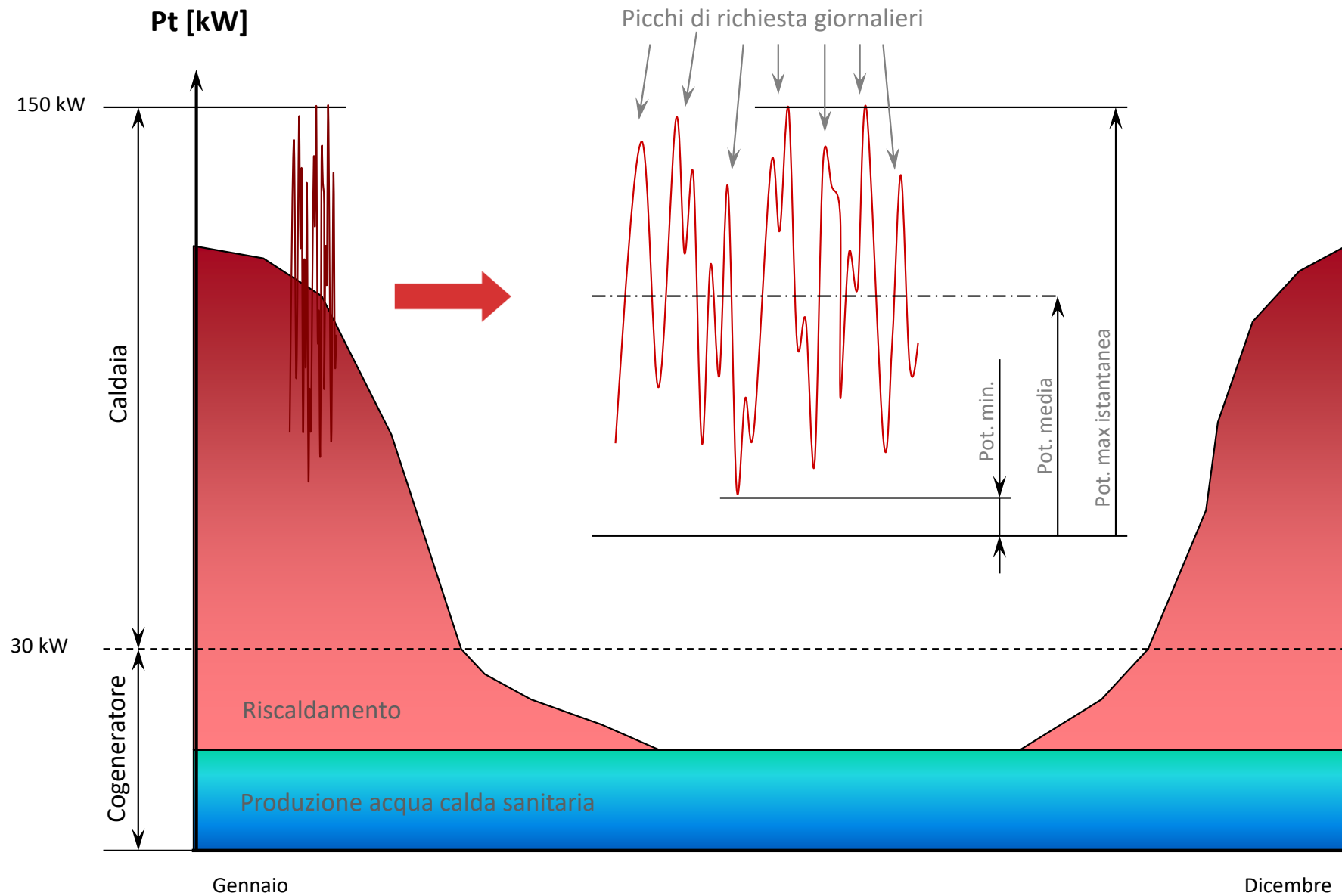

**Potenza termica richiesta**

# Copertura del fabbisogno termico

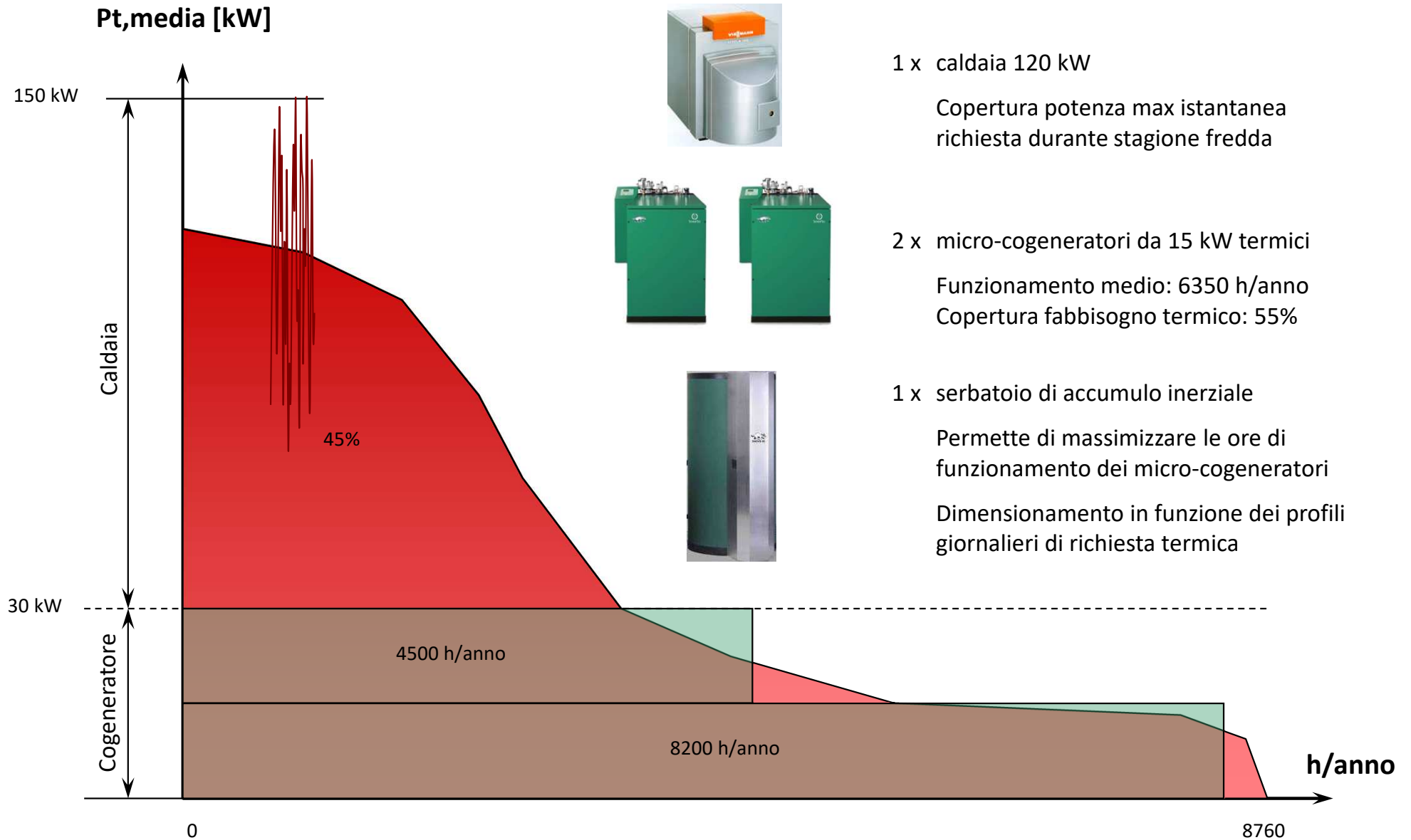

1 x caldaia 120 kW

Copertura potenza max istantanea richiesta durante stagione fredda



2 x micro-cogeneratori da 15 kW termici

Funzionamento medio: 6350 h/anno  
Copertura fabbisogno termico: 55%



1 x serbatoio di accumulo inerziale

Permette di massimizzare le ore di funzionamento dei micro-cogeneratori  
Dimensionamento in funzione dei profili giornalieri di richiesta termica

**Curva cumulata**

# Ruolo dell'accumulo termico

(zona climatica E)

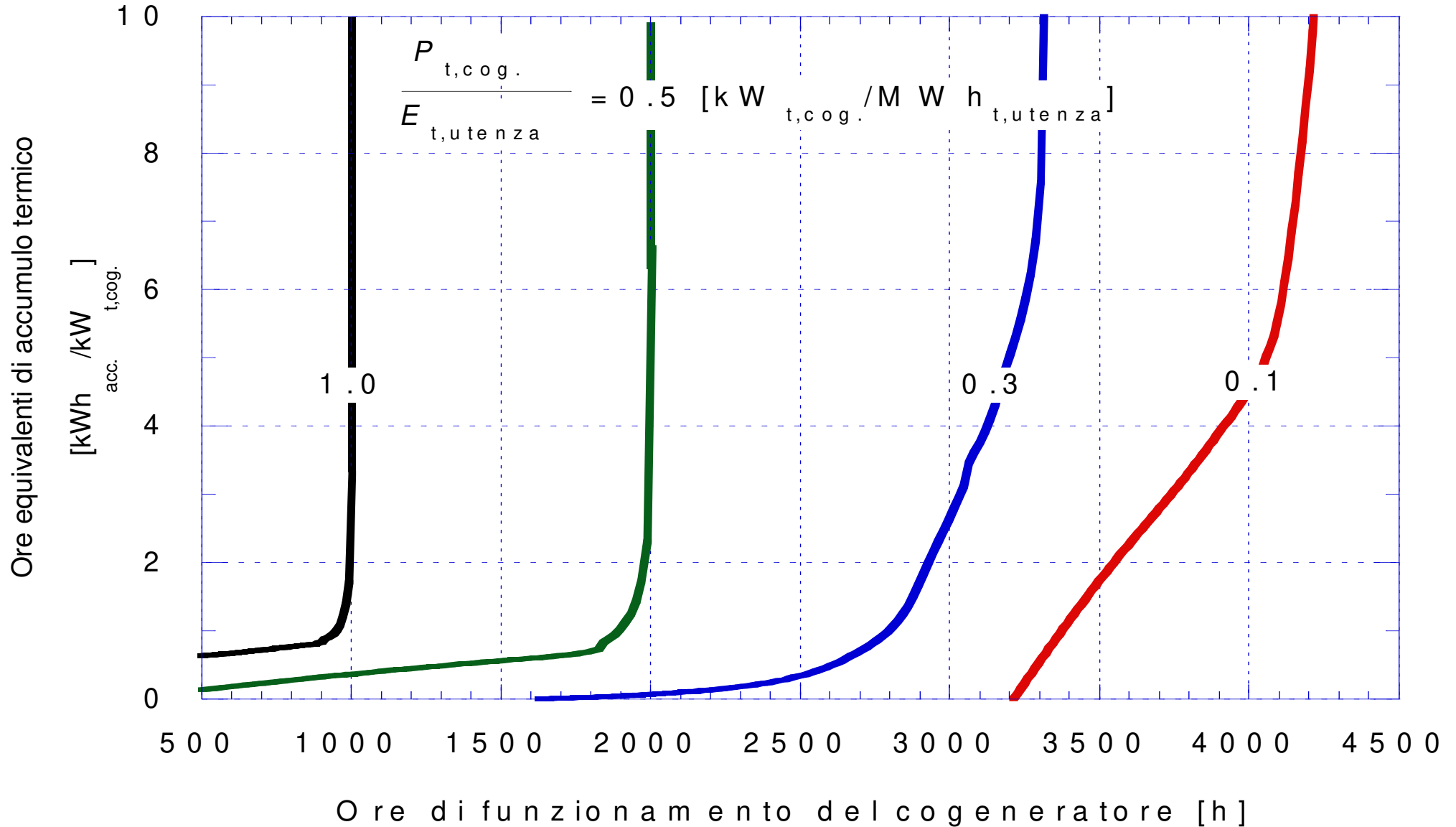

# Ruolo dell'accumulo termico

(zona climatica E)

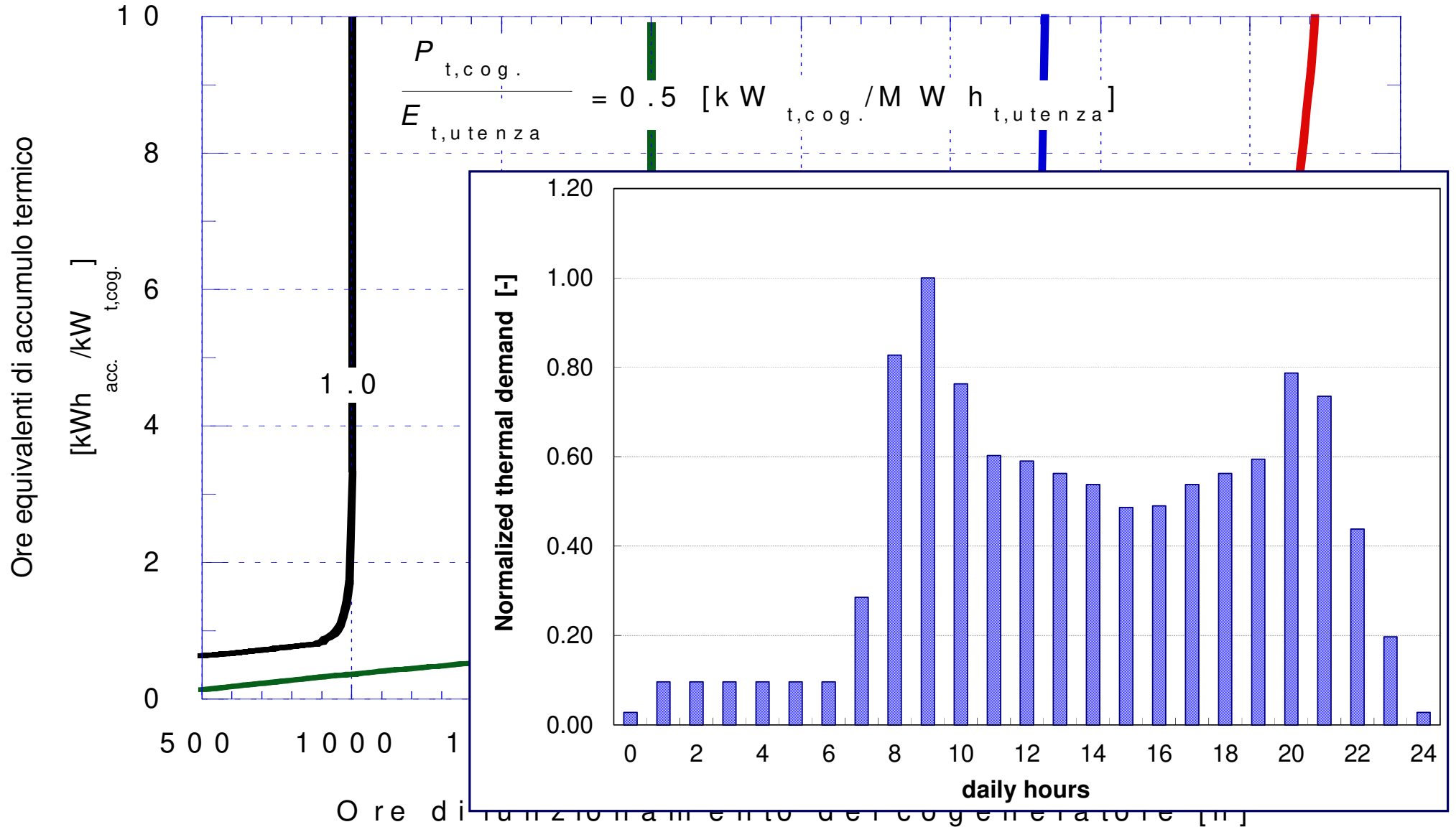

# *Ruolo dell'accumulo termico*

(zona climatica E)

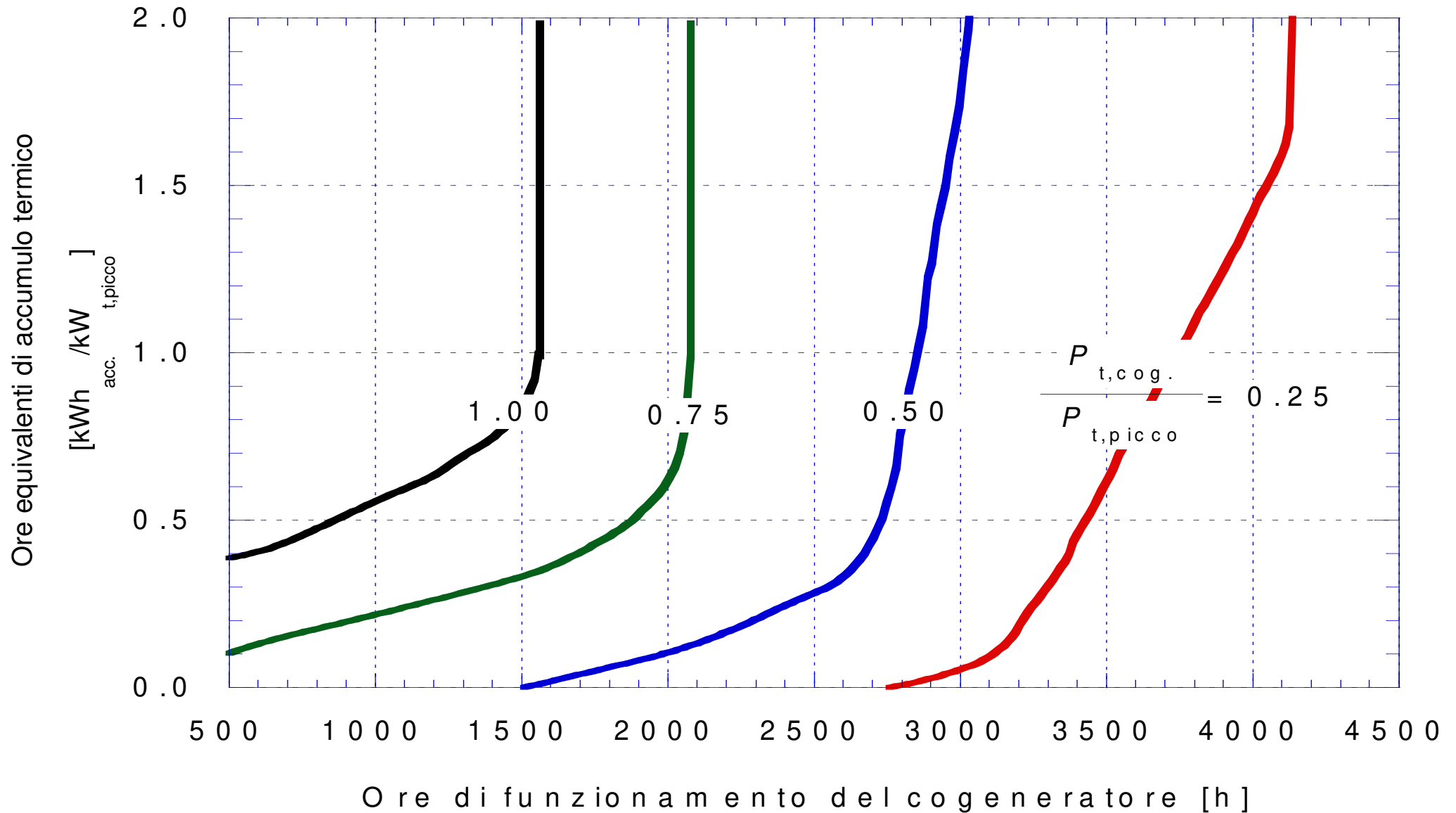

# Trigenerazione: la necessità

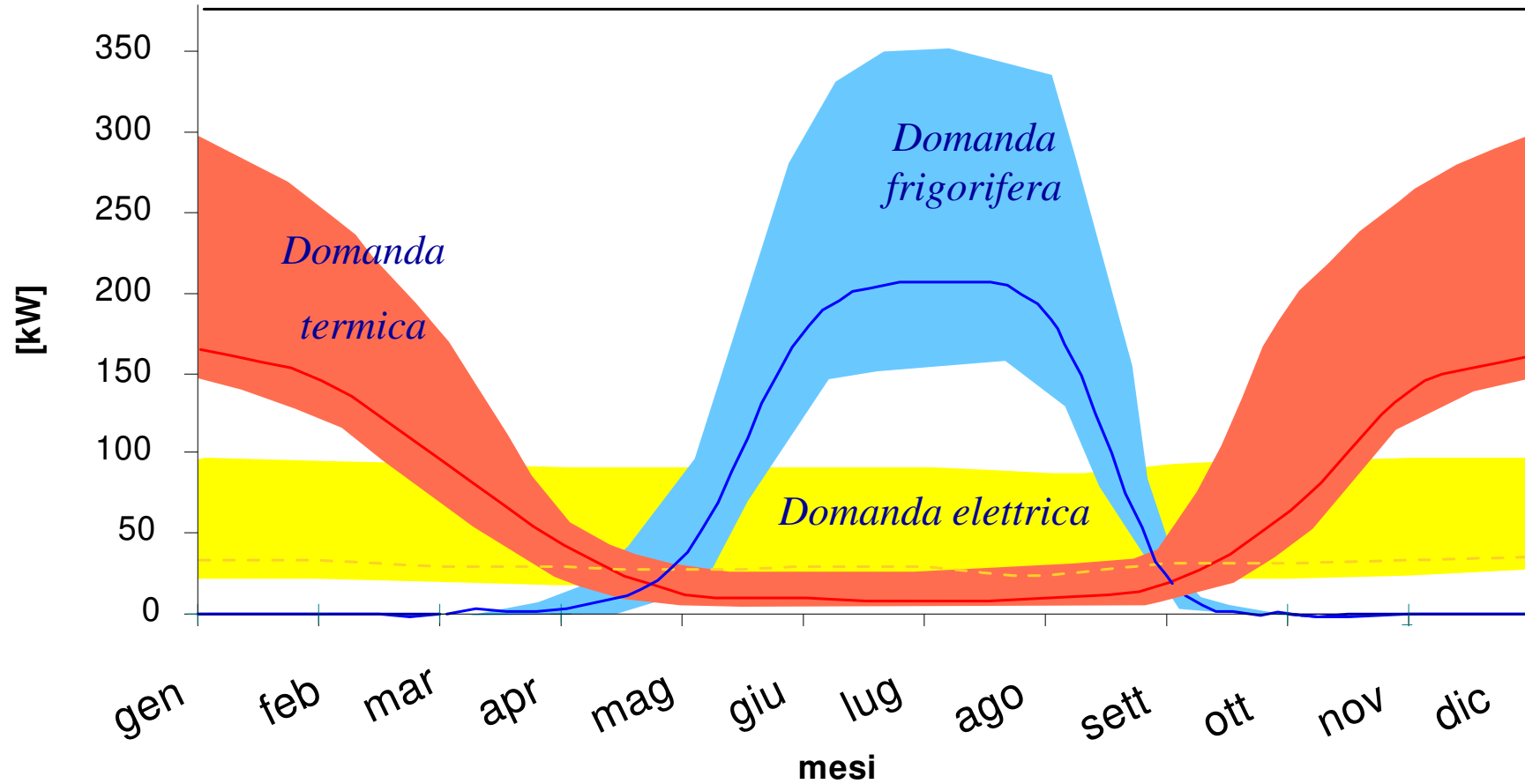

# Trigenerazione: la variabilità del carico

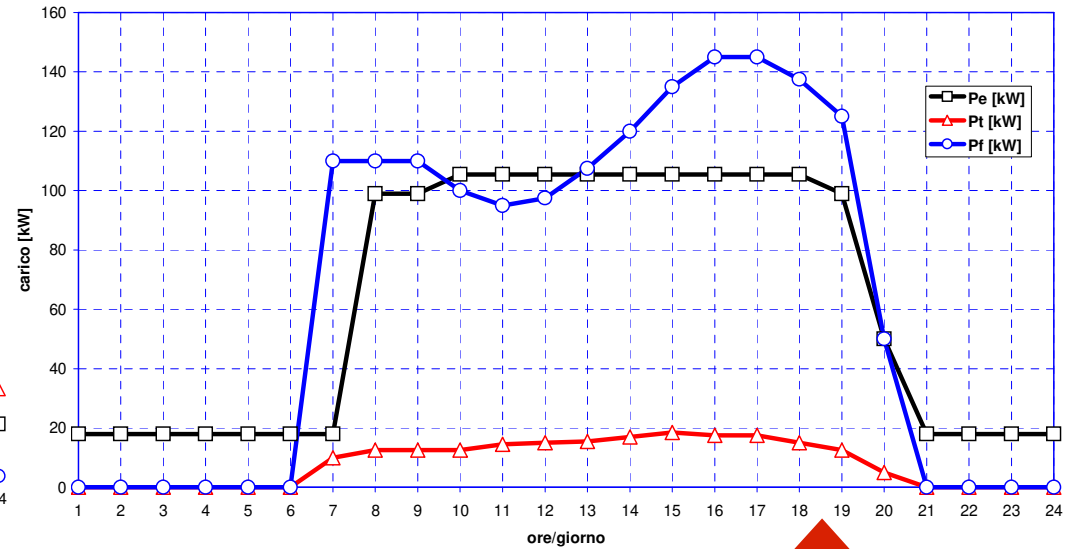
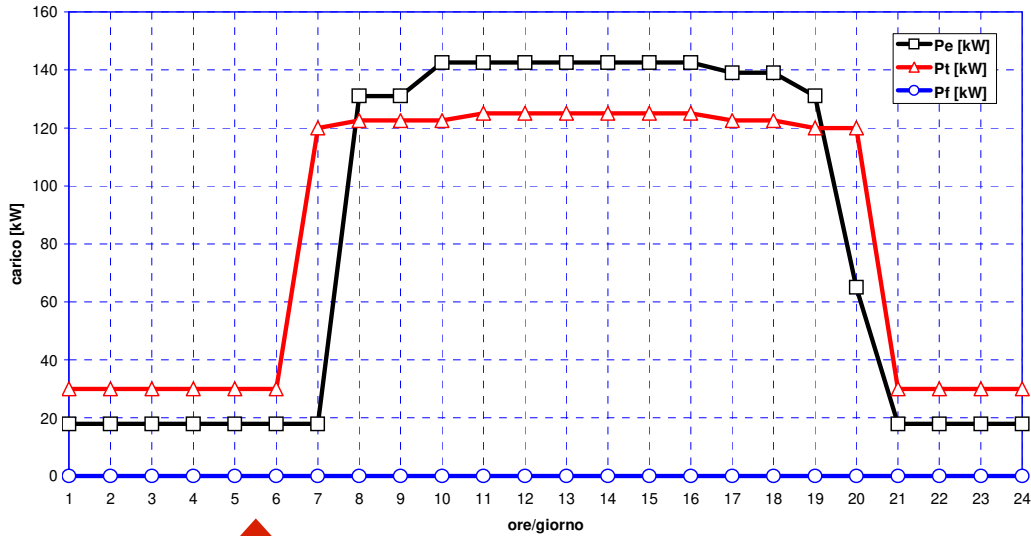

**utenza nel  
terziario  
(inverno)**

**utenza nel  
civile  
(inverno)**

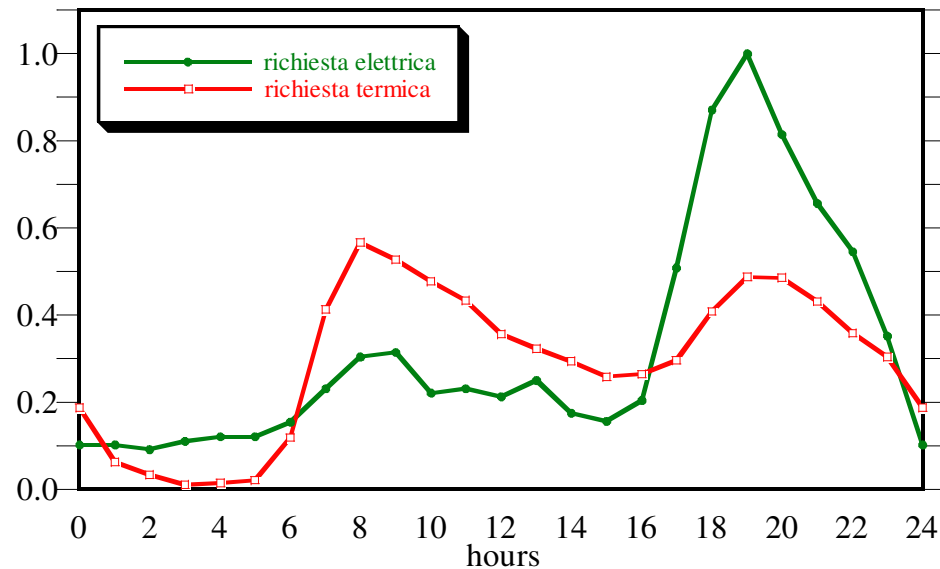

**utenza nel  
terziario  
(estate)**



# Trigenerazione: gli impianti Frigorifero a compressione

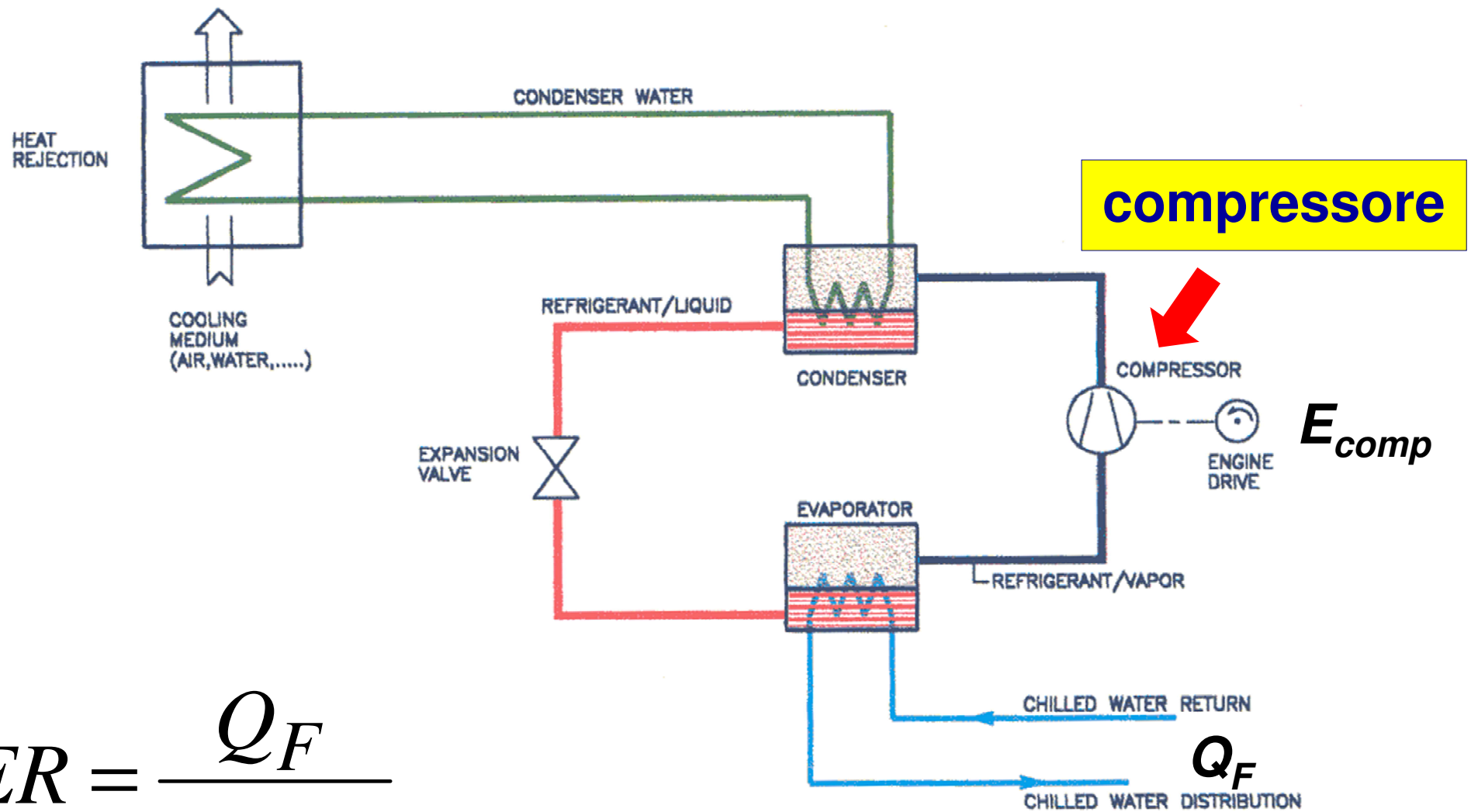

$$EER = \frac{Q_F}{E_{comp}}$$

# Trigenerazione: gli impianti Frigorifero ad assorbimento

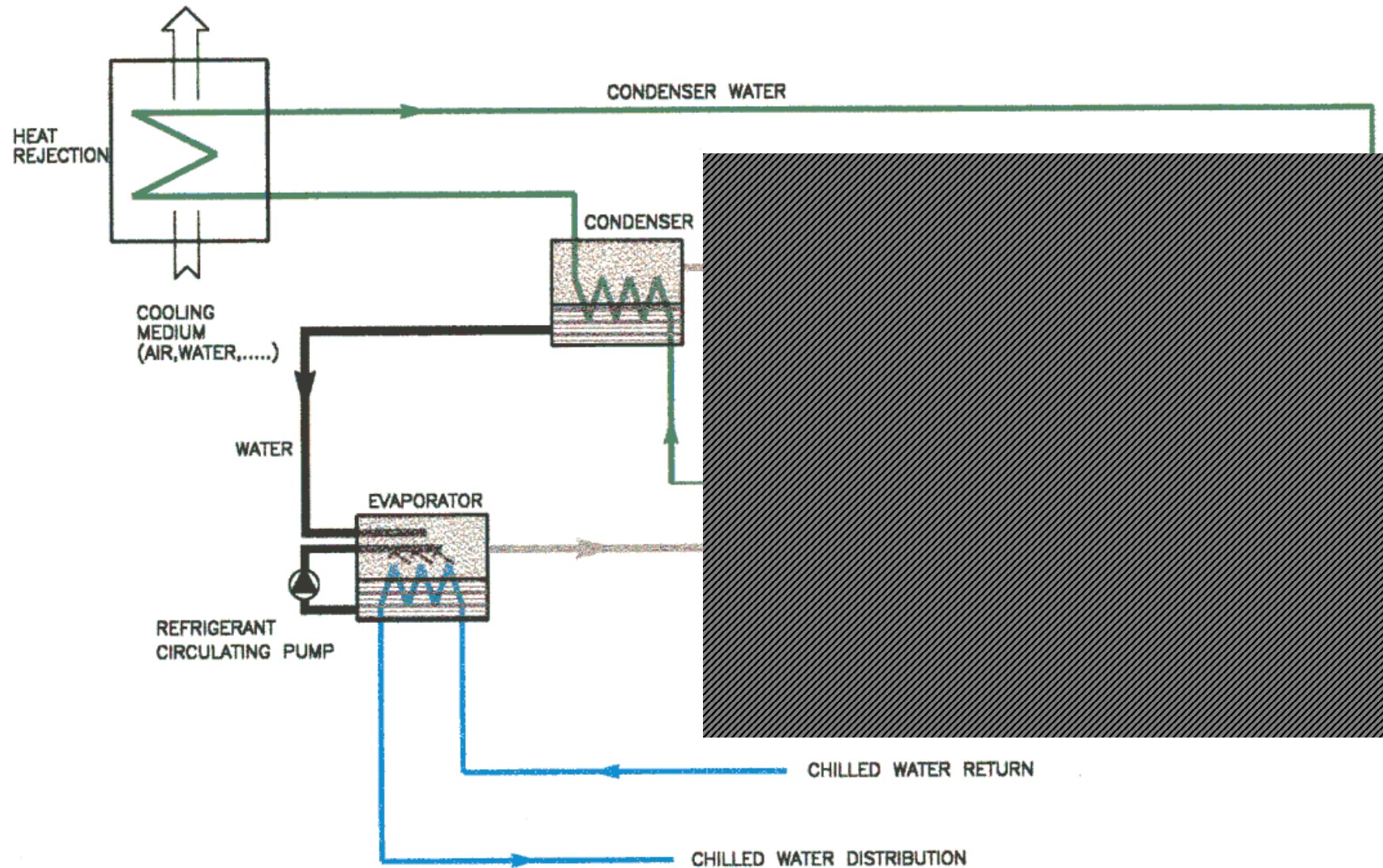

# Trigenerazione: gli impianti Frigorifero ad assorbimento

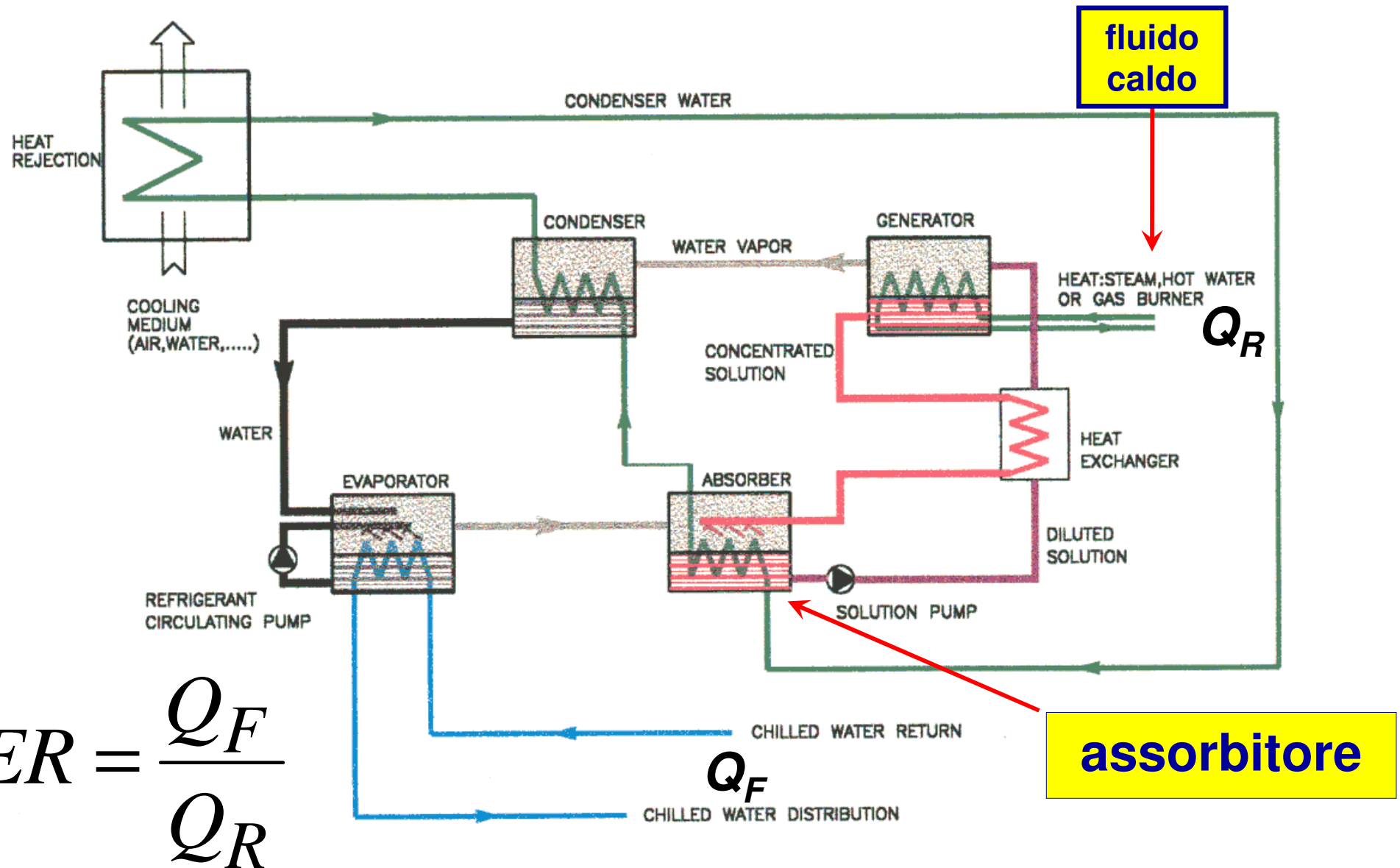

$$EER = \frac{Q_F}{Q_R}$$

# Frigoriferi ad assorbimento ammoniaca-acqua ( $NH_3-H_2O$ ) (temp. refrigerante fino a $-40 \div -60 \text{ } ^\circ\text{C}$ )

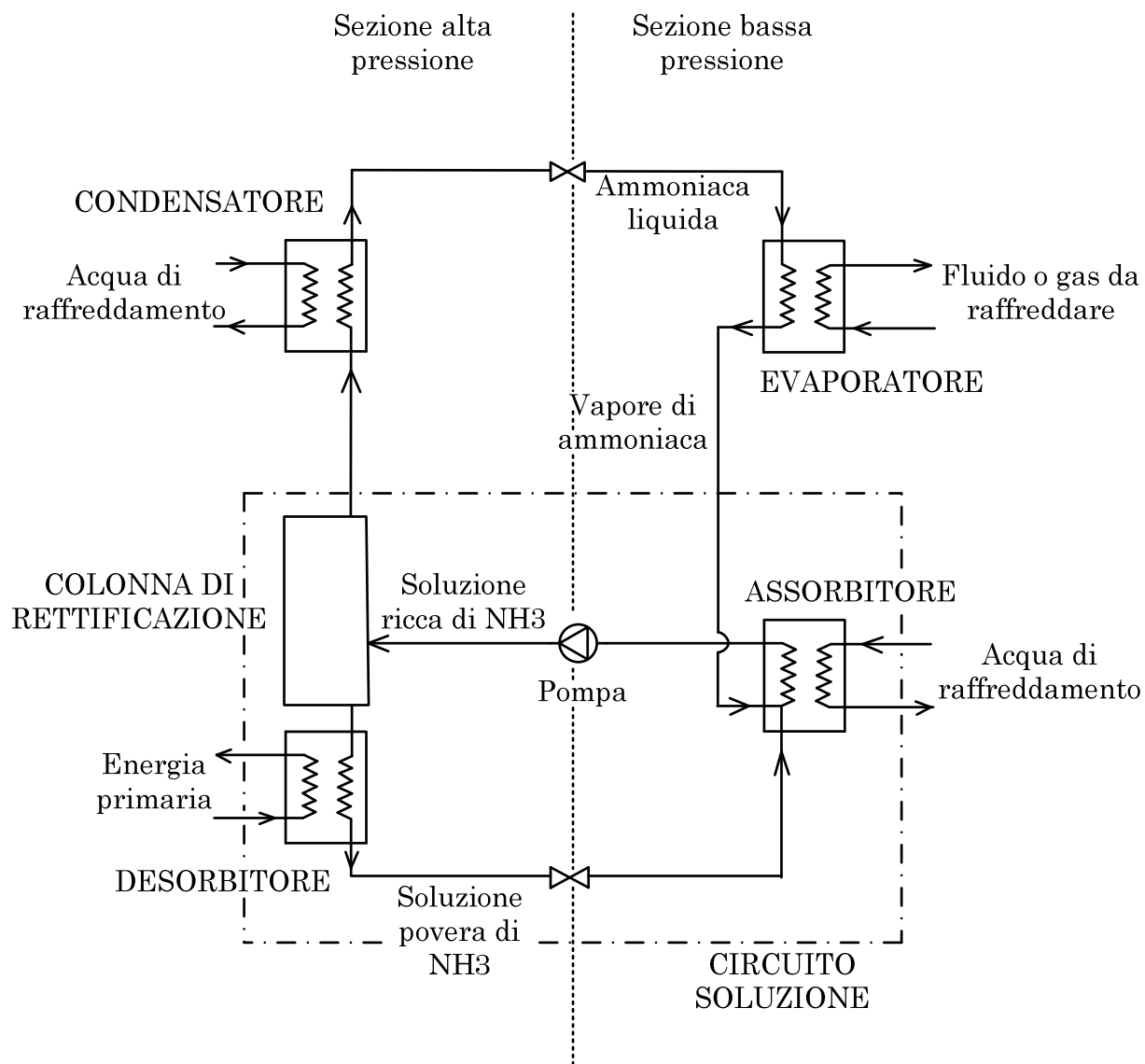

# **Frigoriferi ad assorbimento acqua-bromuro di litio ( $H_2O-BrLi$ ) (temperatura refrigerante $> 0\text{ }^\circ\text{C}$ )**

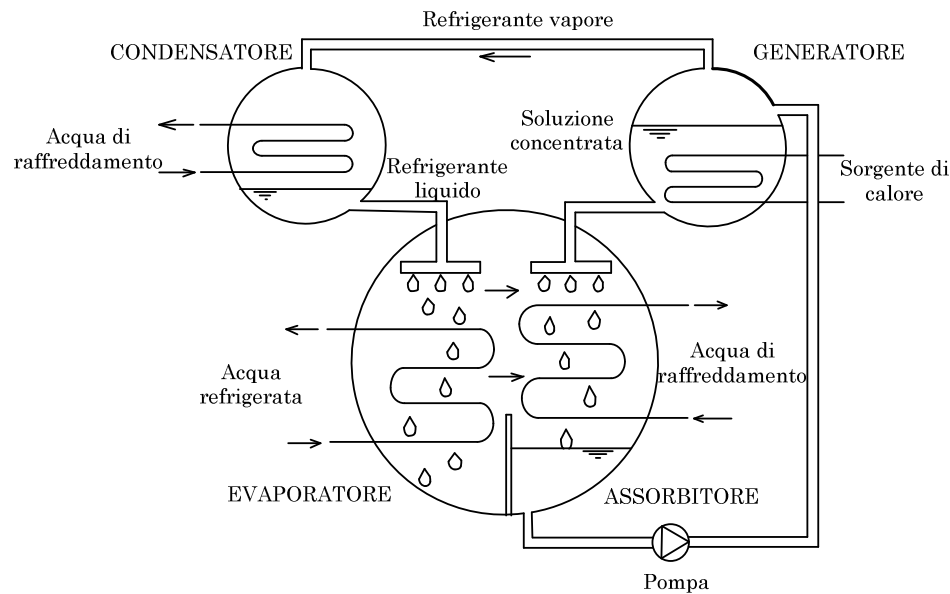

## **Semplice effetto**

$$T_{\text{sorgente calore}} \approx 60 \div 130\text{ }^\circ\text{C}$$

$$\text{EER} \approx 0.60 \div 0.75$$

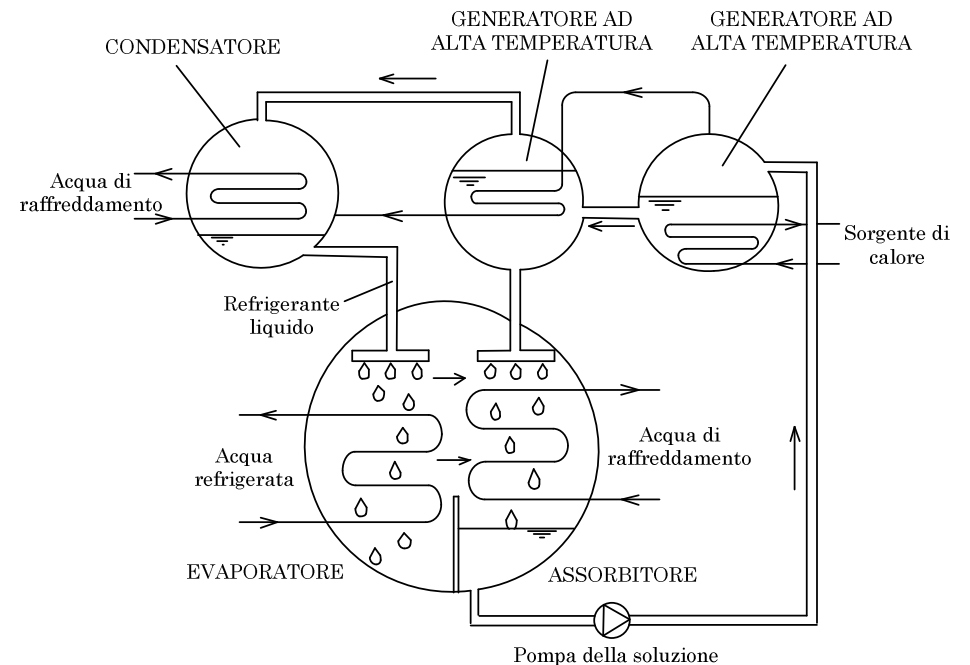

## **Doppio effetto**

$$T_{\text{sorgente calore}} \approx 150 \div 200\text{ }^\circ\text{C}$$

$$\text{EER} \approx 1.1 \div 1.3$$

## *Frigoriferi ad assorbimento: prestazioni*

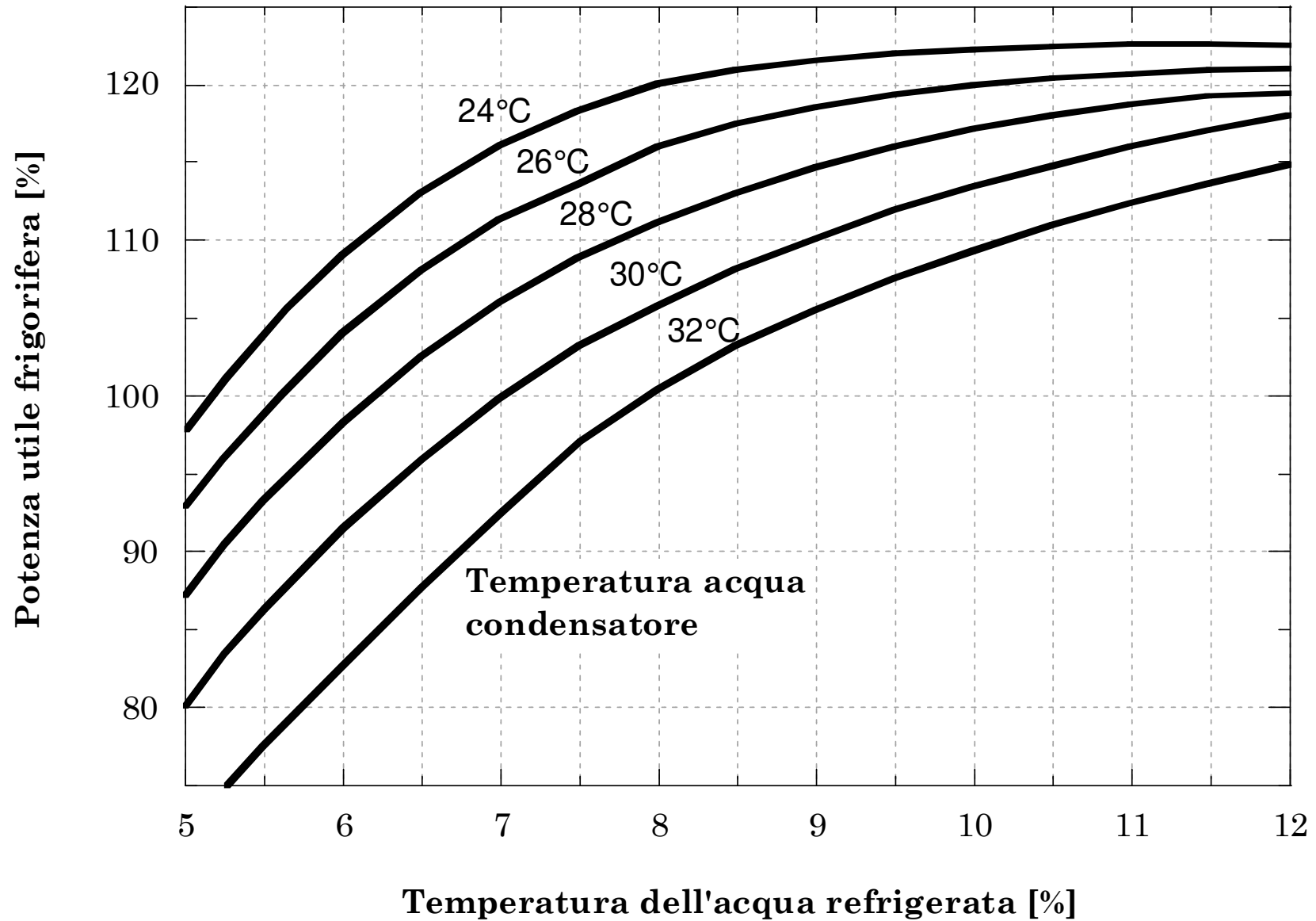

# Frigoriferi ad assorbimento: Funzionamento ai carichi parziali

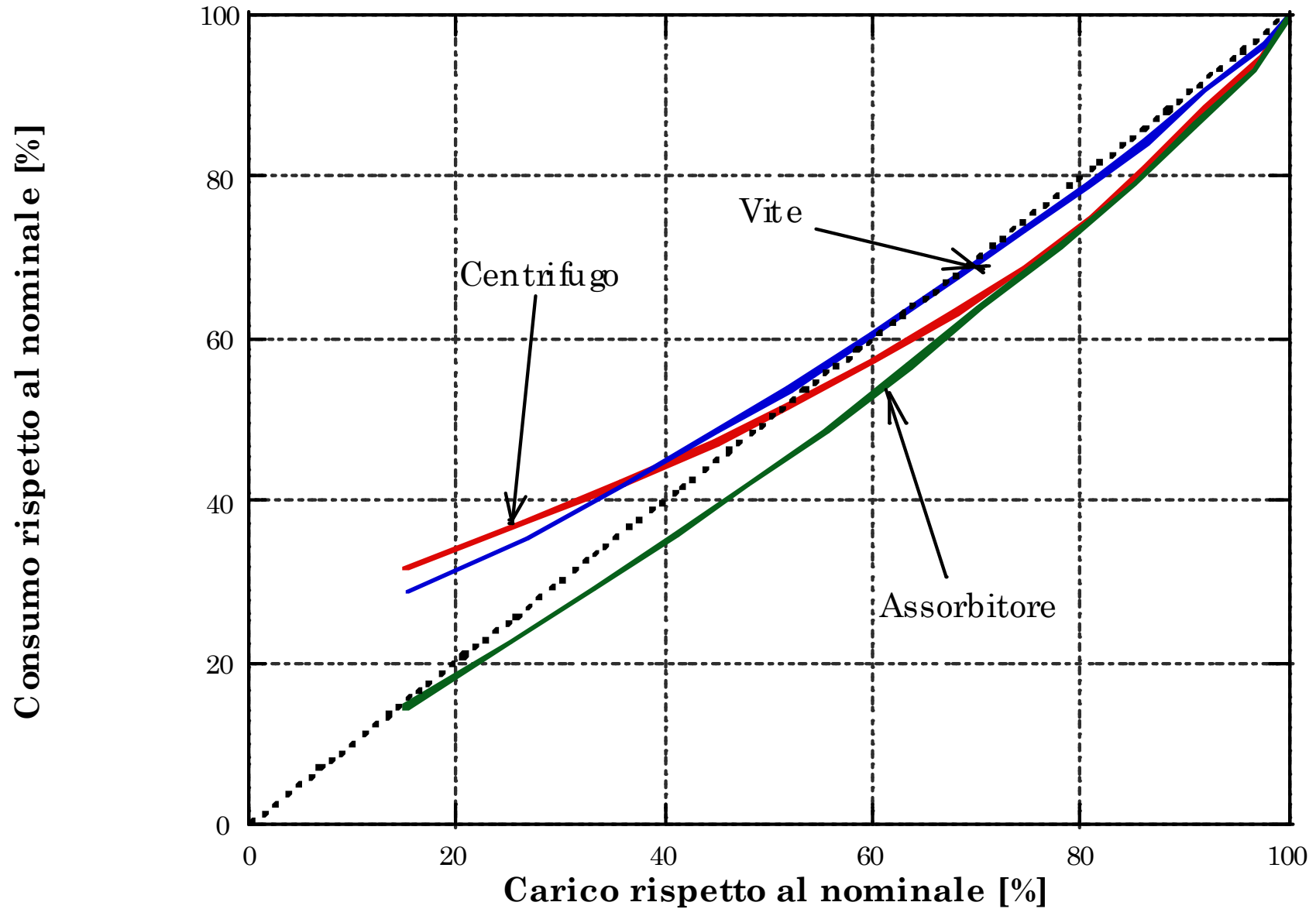

# Trigenerazione: gli impianti Desiccant cooling

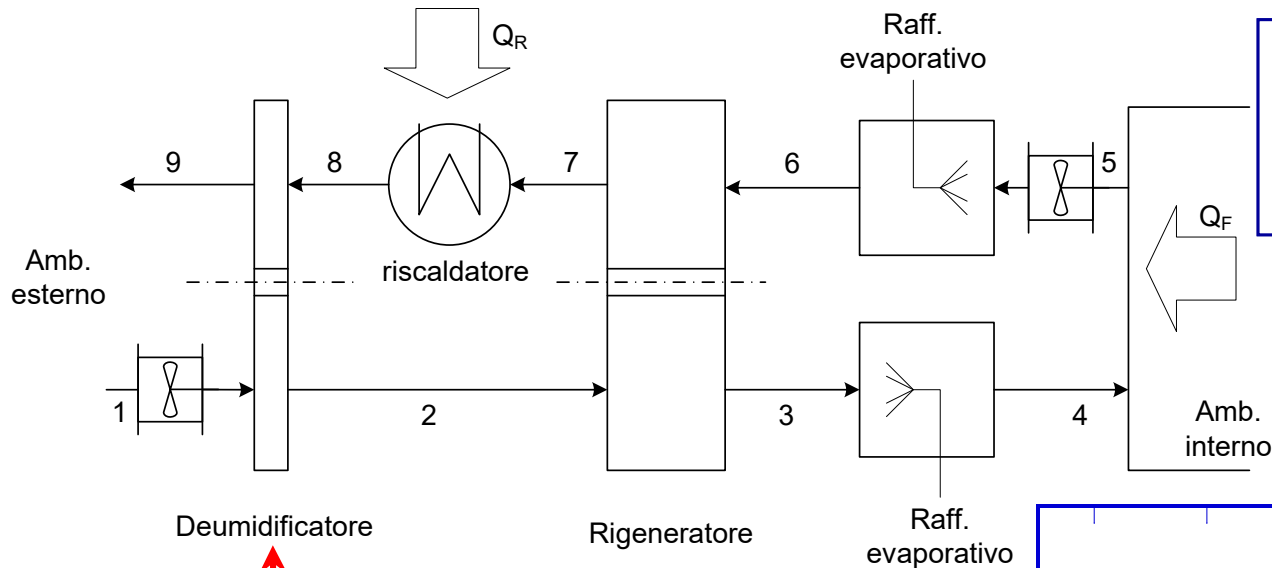

- ✓ **EER ≈ 0.5 ÷ 0.6**
- ✓  **$Q_F/E_{el} \approx 5 \div 6$**
- ✓ **Assenza di fluidi pericolosi**

$$EER = \frac{Q_F}{Q_R}$$

**deumidificatore igroscopico  
(con sostanze chimiche "silica gel")**

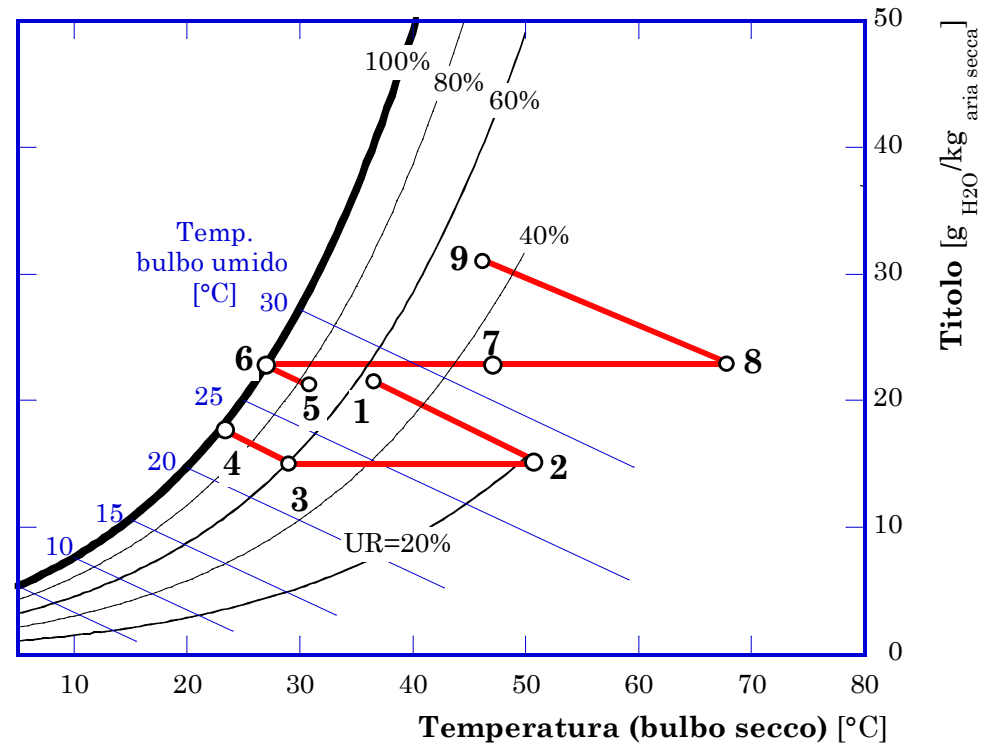
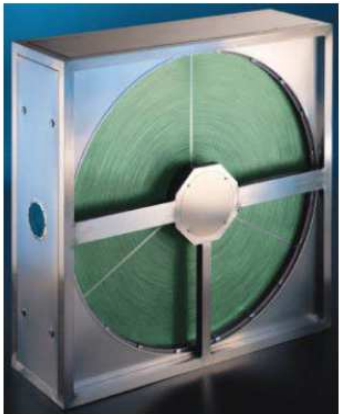



# Trigenerazione: le applicazioni

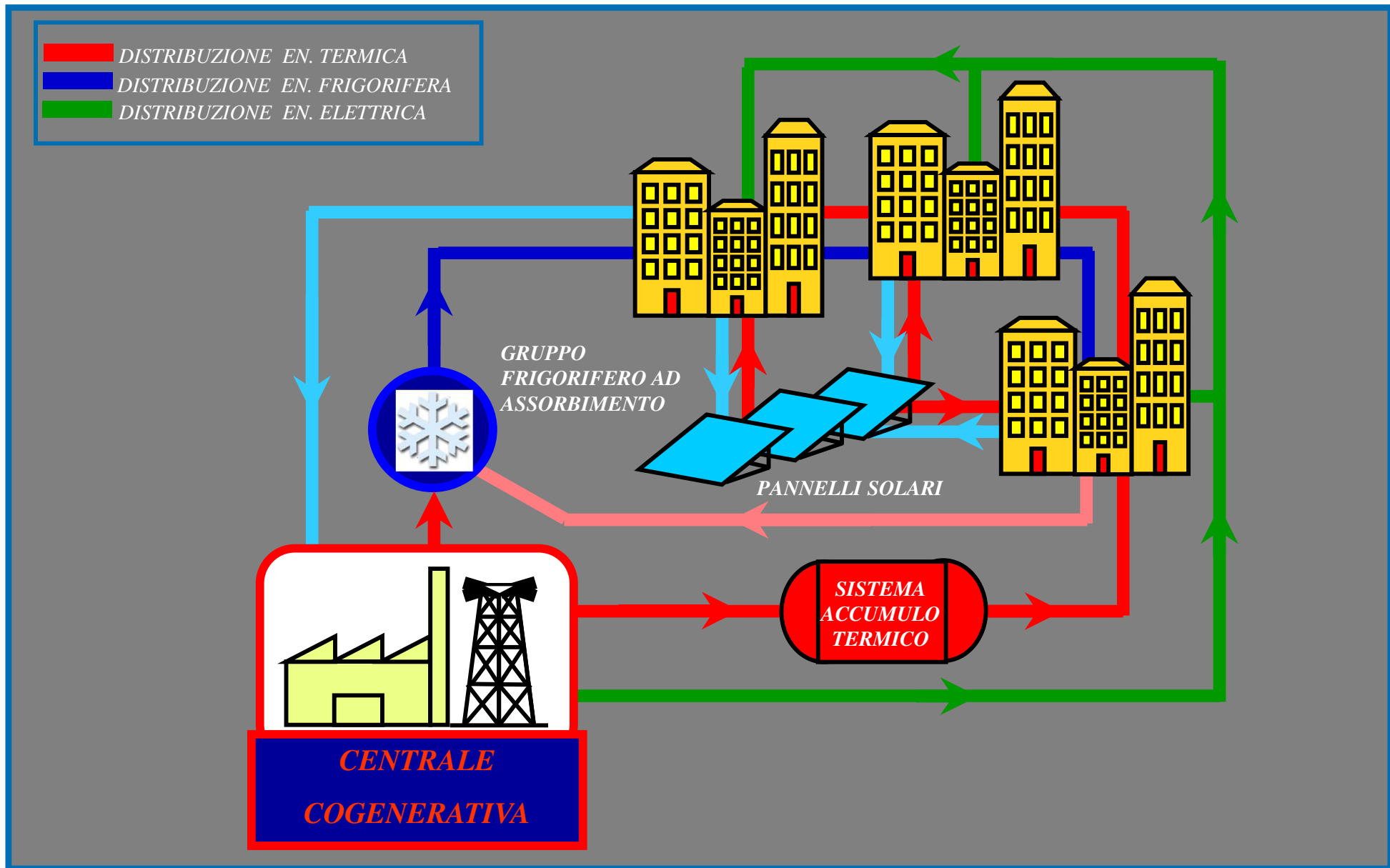

# Trigenerazione: le applicazioni

