

Rapporto fra architettura e ambiente/clima ...

mesoambiente - involucro edilizio (filtro) - macroambiente

OBIETTIVI NZEB o POSITIVE:

- involucro efficiente_riduzione consumi e miglioramento qualità ambientale indoor
- impianti efficienti (per es. VMC+recupero di calore)
- produzione energia residua con fonti rinnovabili

- fra **globalizzazione** linguaggio architettonico e **regionalismo architettonico** (anni '80)
- fra **architettura sostenibile "nascosta"** e **architettura sostenibile in evidenza** con un proprio linguaggio

... per un corretto inserimento ambientale ed una corretta contestualizzazione dell'edificio nell'area di progetto.

ARCHITETTURA E AMBIENTE

ARCHITETTURA **BIOCLIMATICA**

ARCHITETTURA SOLARE

BIOARCHITETTURA

ARCHITETTURA ECOLOGICA

SISTEMI SOLARI PASSIVI

TECNOLOGIE SOSTENIBILI

REGIONALISMO ARCHITETTONICO

ARCHITETTURA **SPONTANEA**

ARCHITETTURA **PREINDUSTRIALE**

"ARCHITETTURA **SENZA ARCHITETTI**"

CLIMA E ARCHITETTURA

mesoambiente

filtro (involucro edilizio)

macroambiente

Tutte accezioni confluite nel concetto di SOSTENIBILITA' AMBIENTALE

Quali alcune immediate ricadute del concetto di sviluppo sostenibile?

Vantaggi per es. per un museo. I caratteri di Sostenibilità ambientale (e di efficienza energetica in particolare) contribuiscono a migliorare, tra gli altri fattori:

- la conservazione indoor delle opere esposte (parametri ambientali più stabili e controllabili)
- il comfort indoor degli utenti
- la conservazione degli involucri architettonici di pregio (parametri ambientali più stabili e controllabili)
- la riduzione della produzione/ impatto di gas climalteranti sull'ambiente esterno (outdoor) e dell'uso di risorse non rinnovabili
- la riduzione dei consumi di gestione dell'edificio, che liberano risorse utili per altri fini di salvaguardia e promozione

1

**CONTROLLO DELLE
CONDIZIONI CLIMATICHE**
attraverso:

**CONTROLLO DELL'IRRAGGIAMENTO
SOLARE**

CONTROLLO DELLA TEMPERATURA
inerzia termica
coibenza termica

CONTROLLO DEL RUMORE ESTERNO
coibenza acustica
fonoassorbenza

**ALLONTANAMENTO O RACCOLTA
DELLE PRECIPITAZIONI**

2

**DIFESA DAI VENTI O INCENTIVAZIONE
DELLA VENTILAZIONE NATURALE
DEGLI AMBIENTI**

SFRUTTAMENTO:

- **DELL'OROGRAFIA DEL LUOGO E
DELL'ALTITUDINE**
- **DELL'AZIONE ISOLANTE DEL
TERRENO**
- **DELLA VEGETAZIONE**
- **DELLA PRESENZA DI GRANDI
MASSE D'ACQUA**

3

STUDIO:

- **DELLA MORFOLOGIA DEL
TESSUTO EDILIZIO (layout)**
- **DEL RAPPORTO FRA SPAZI
ESTERNI, SPAZI INTER-ESTERNI ED
EDIFICIO**
- **DELLA MORFOLOGIA GENERALE
DELL'INVOLUCRO EDILIZIO**
- **DELLA FORMA E DEI MATERIALI
DEGLI ELEMENTI CHE
COMPONGONO L'INVOLUCRO
EDILIZIO**

*Il fine ultimo é il soddisfacimento
del requisito di benessere ambientale*

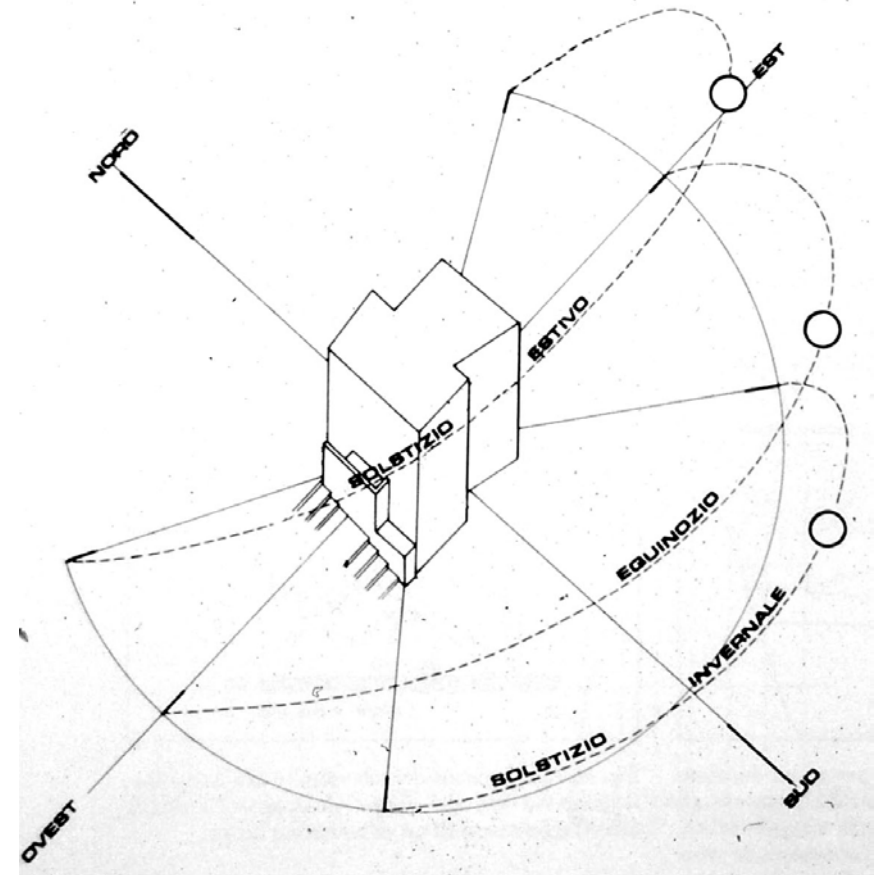
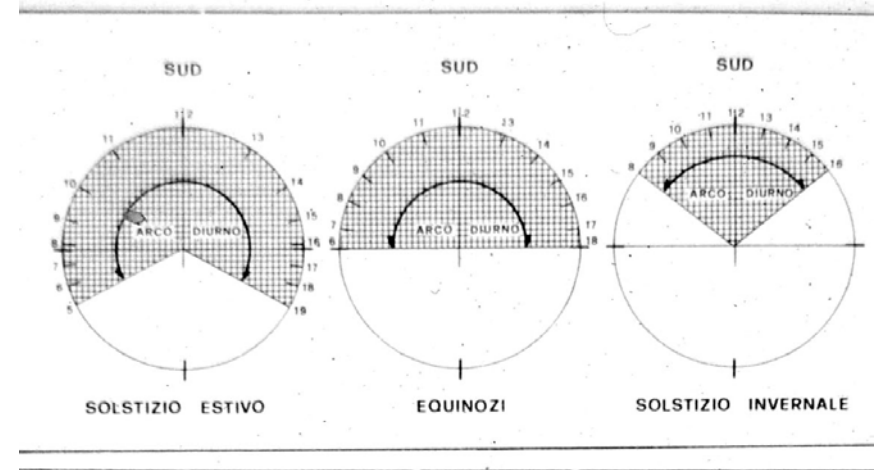
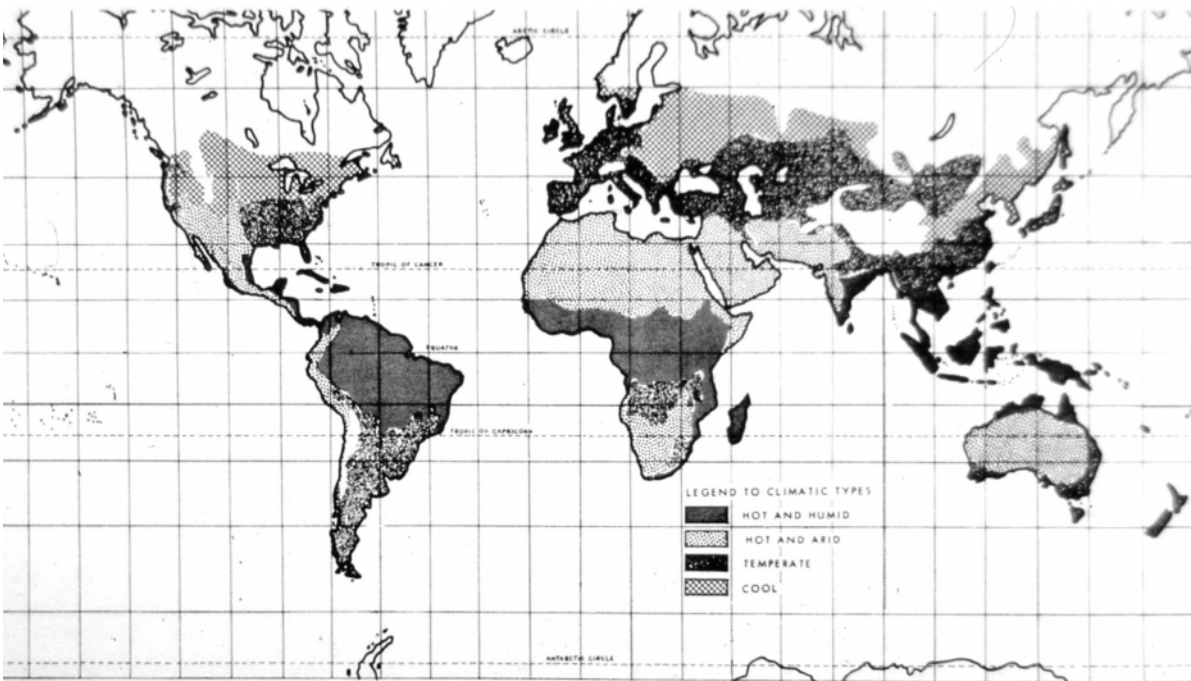

- >AREE CLIMATICHE
- >LINEA EST_OVEST
- >FRONTI EST-OVEST/SUD
- >CARICO TERMICO FRONTE/COPERTURA

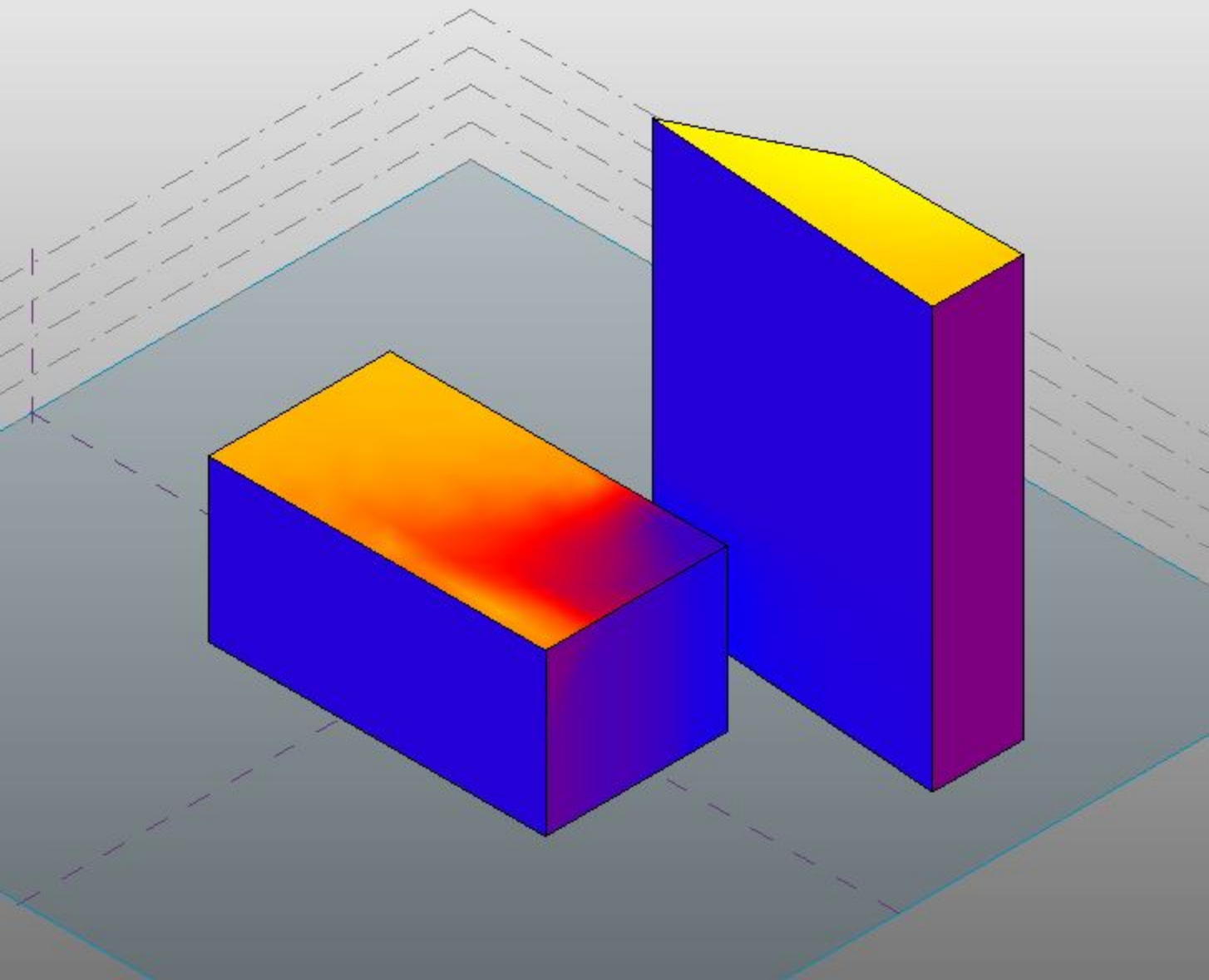

IRINGA | SHADOW RANGE

21 GIUGNO | ore 8.00 - 18.00

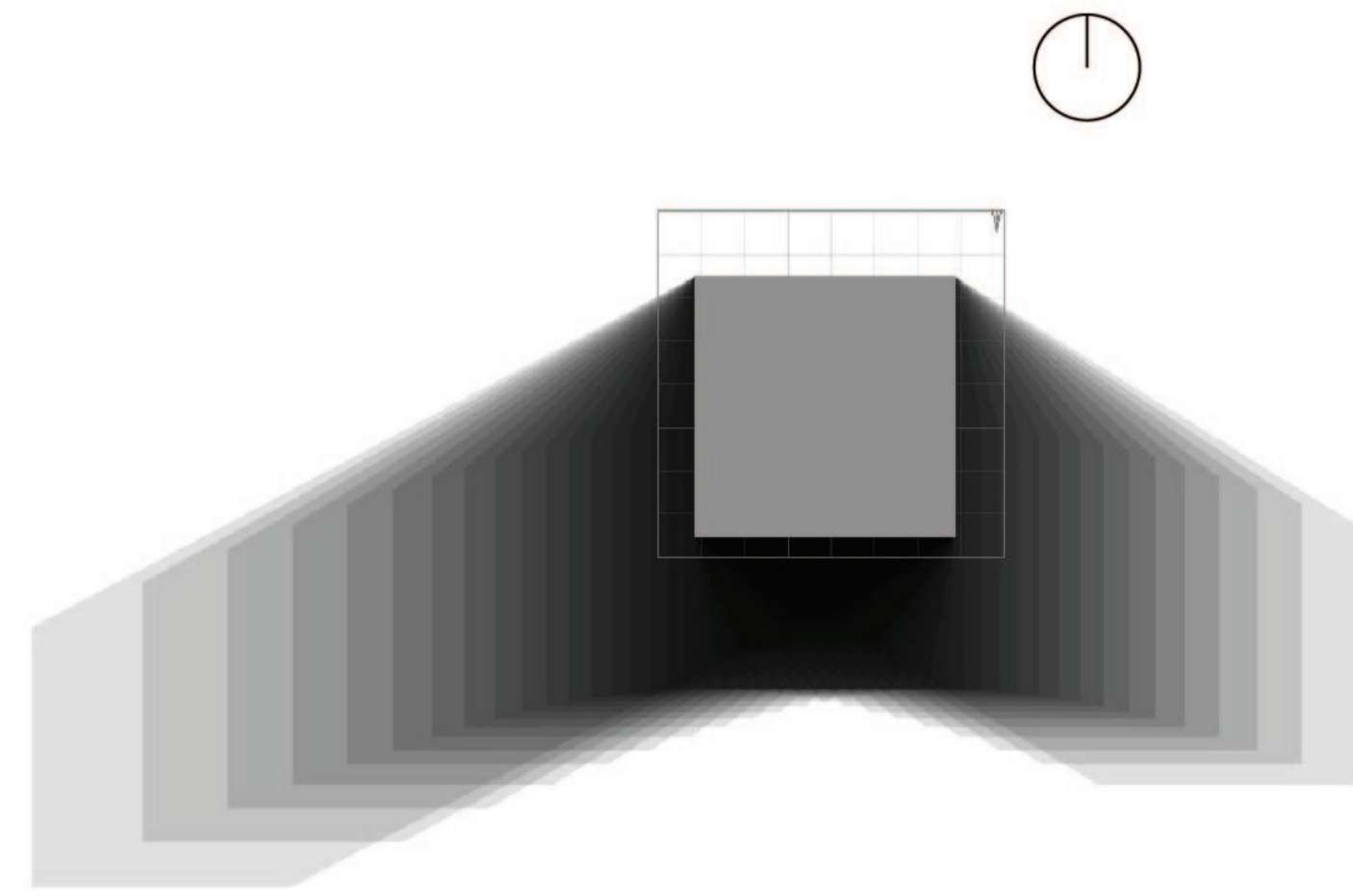
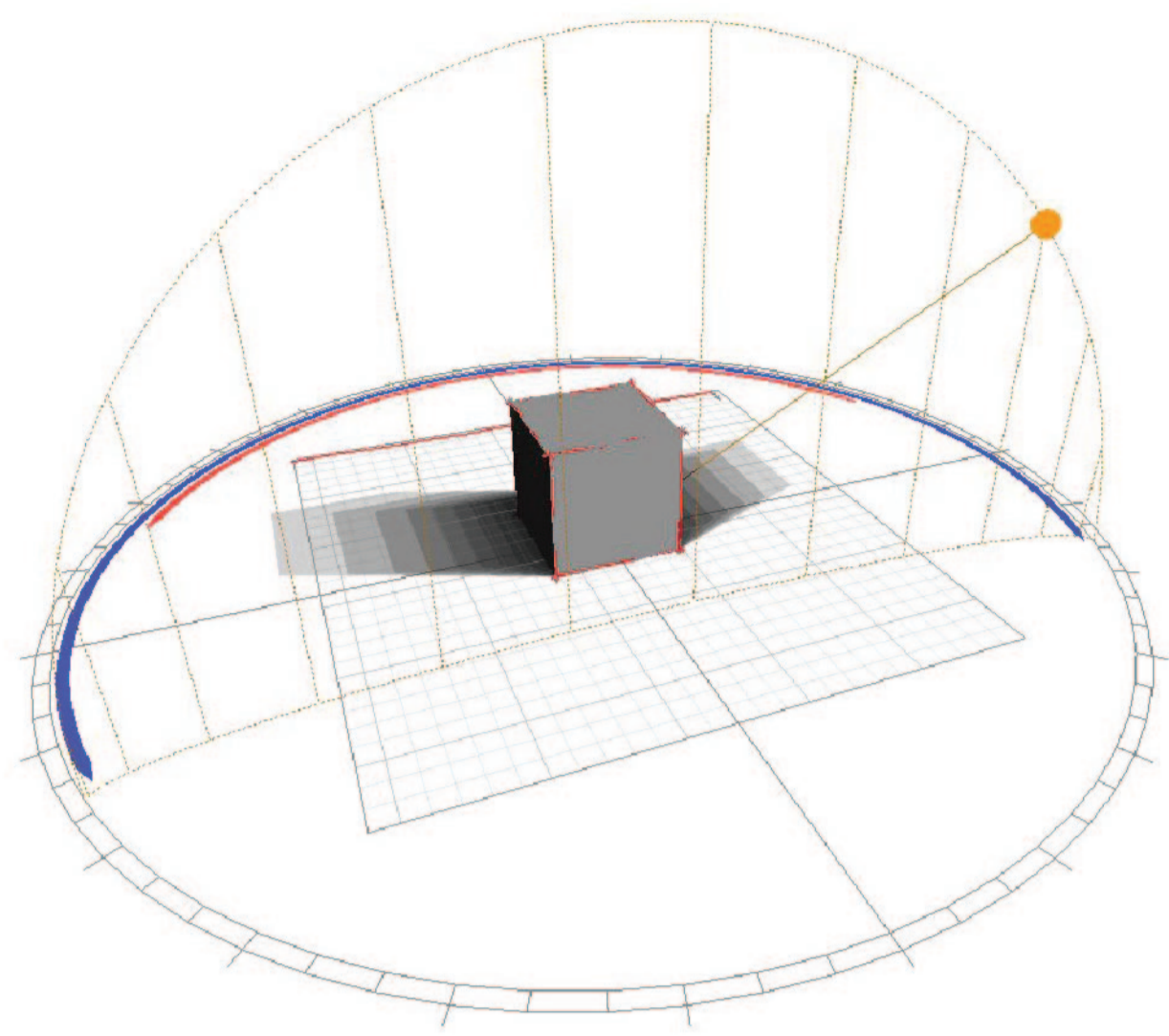

21 DICEMBRE | ore 8.00 - 18.00

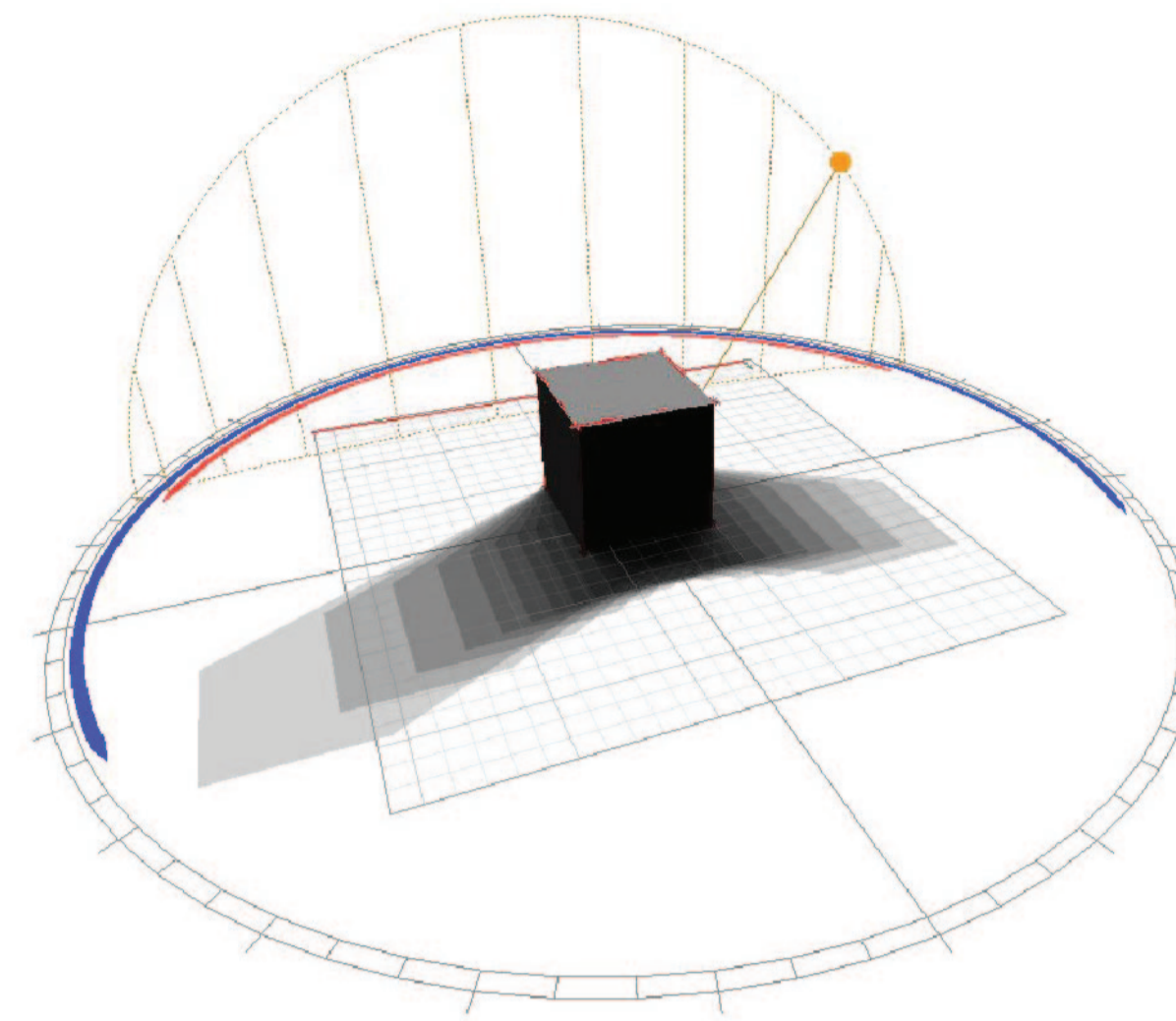

IRRAGGIAMENTO SOLARE | 21 DICEMBRE

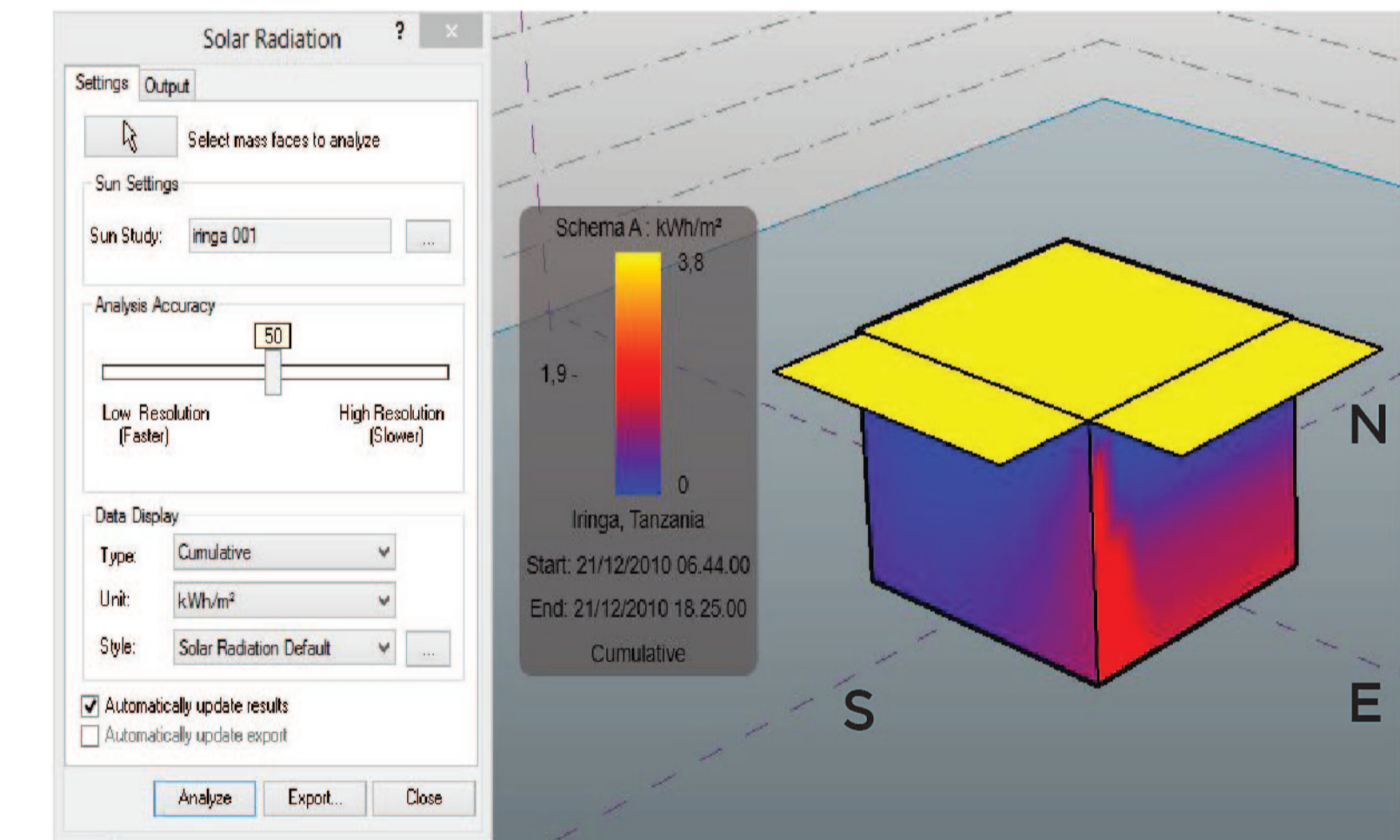
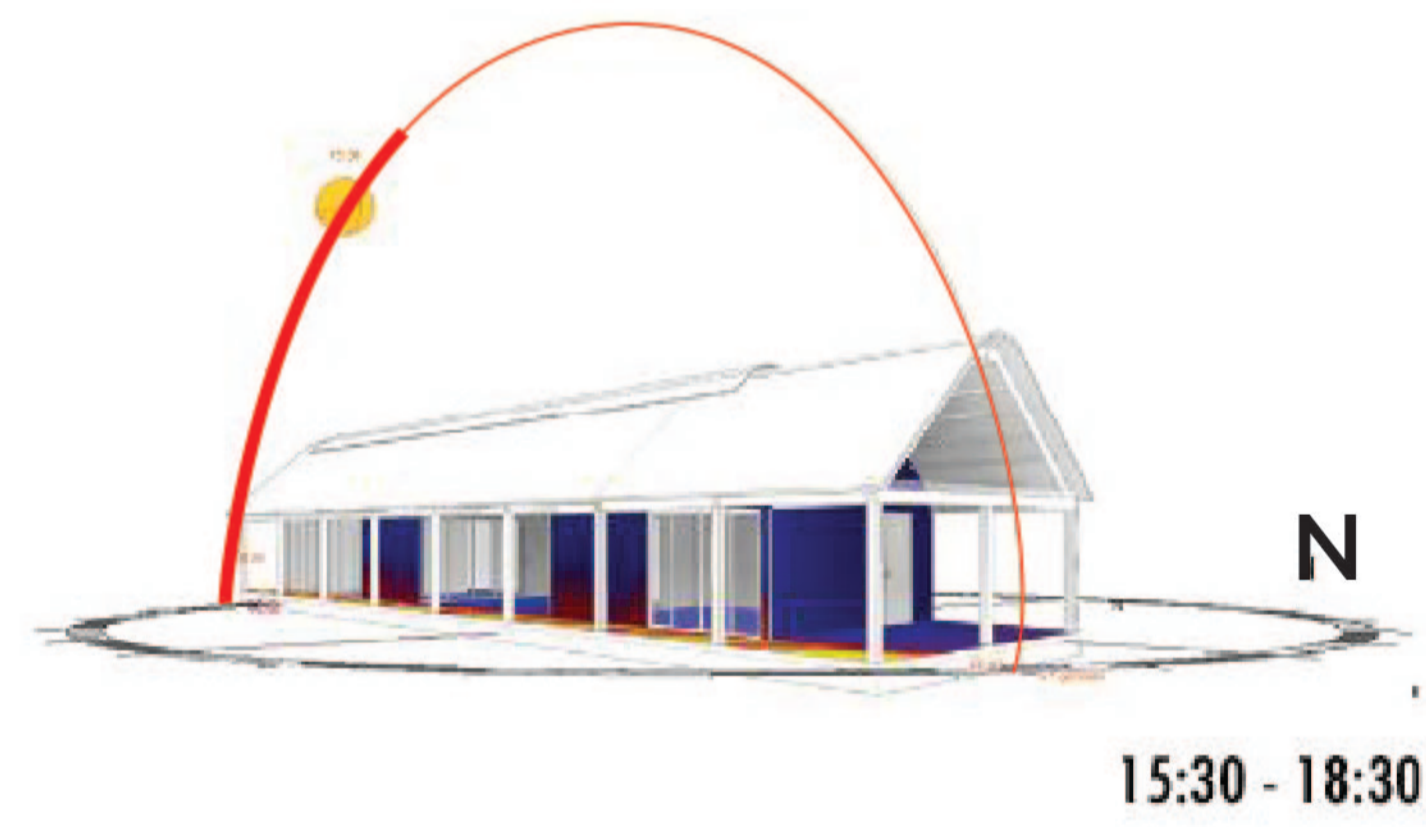
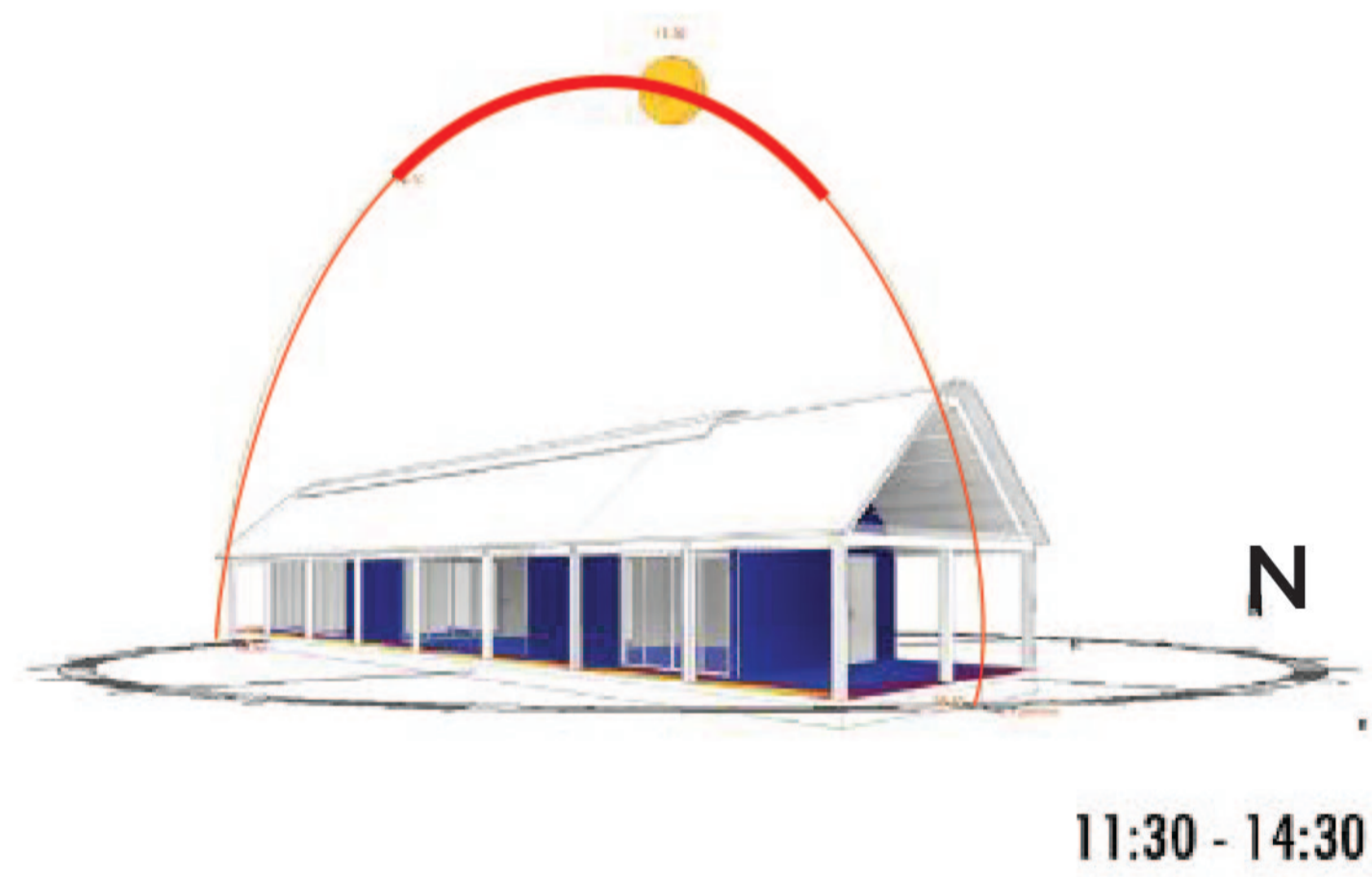
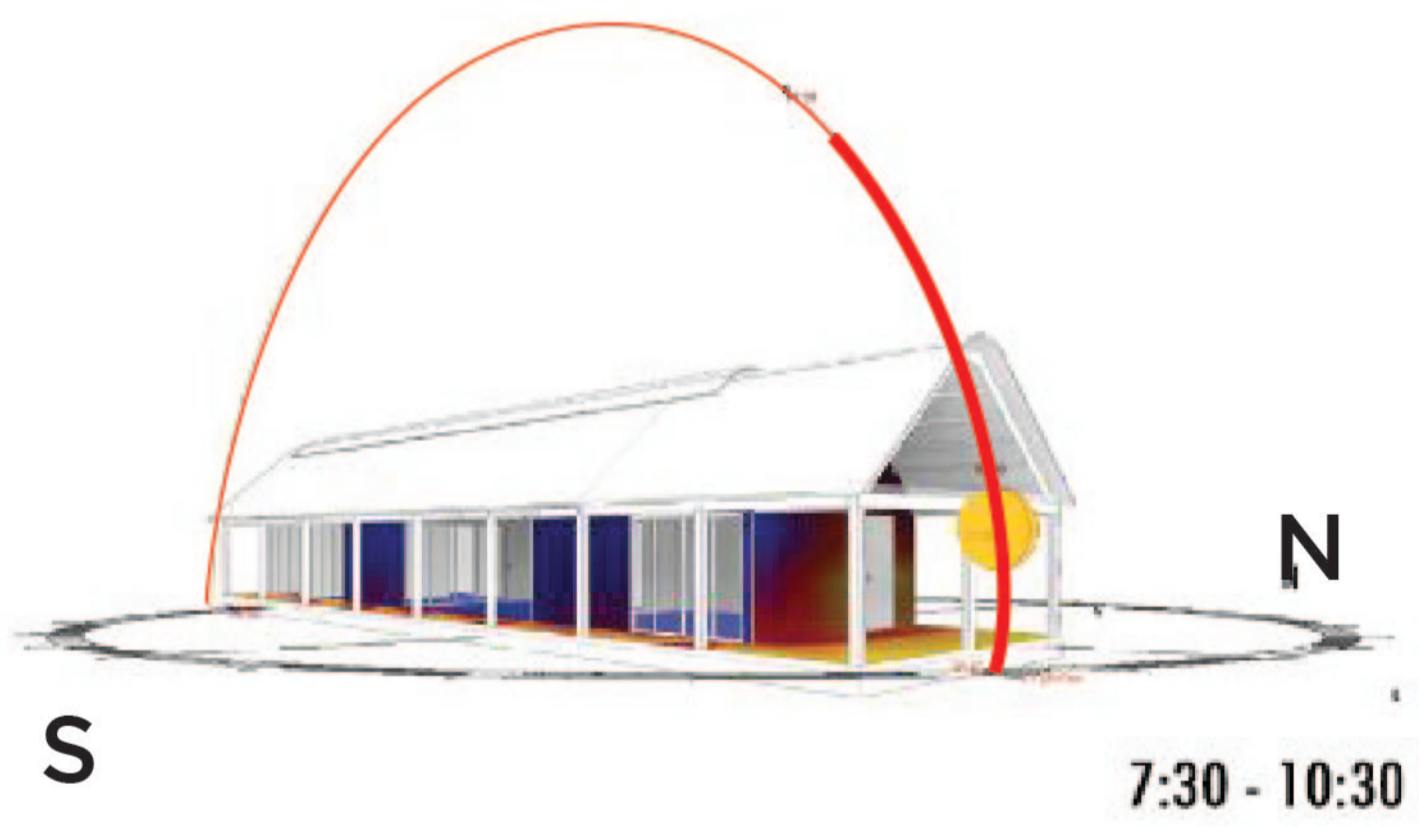



> ESPOSIZIONE/IGIENIZZAZIONE/VENTILAZIONE



Diagramma solare polare - latitudine 39° N

Latitudine 38° N

Altezza ed azimut del sole

	Ora	Altezza	Azimut
21-1	8-16	9,1	55,4
21-11	9-15	18,1	44,3
	10-14	25,4	31,3
	11-13	30,2	16,3
	12	31,9	0
21-2	7-17	4,6	71,9
21-10	8-16	15,5	61,8
	9-15	25,3	50,1
	10-14	33,3	35,9
	11-13	38,8	19,0
	12	40,8	0
21-3	7-17	11,5	80,3
21-9	8-16	22,9	70,1
	9-15	33,6	58,1
	10-14	42,7	42,9
	11-13	49,2	23,3
	12	51,6	0
21-4	6-18	7,1	99,2
21-8	7-17	18,9	90,1
	8-16	30,6	80,4

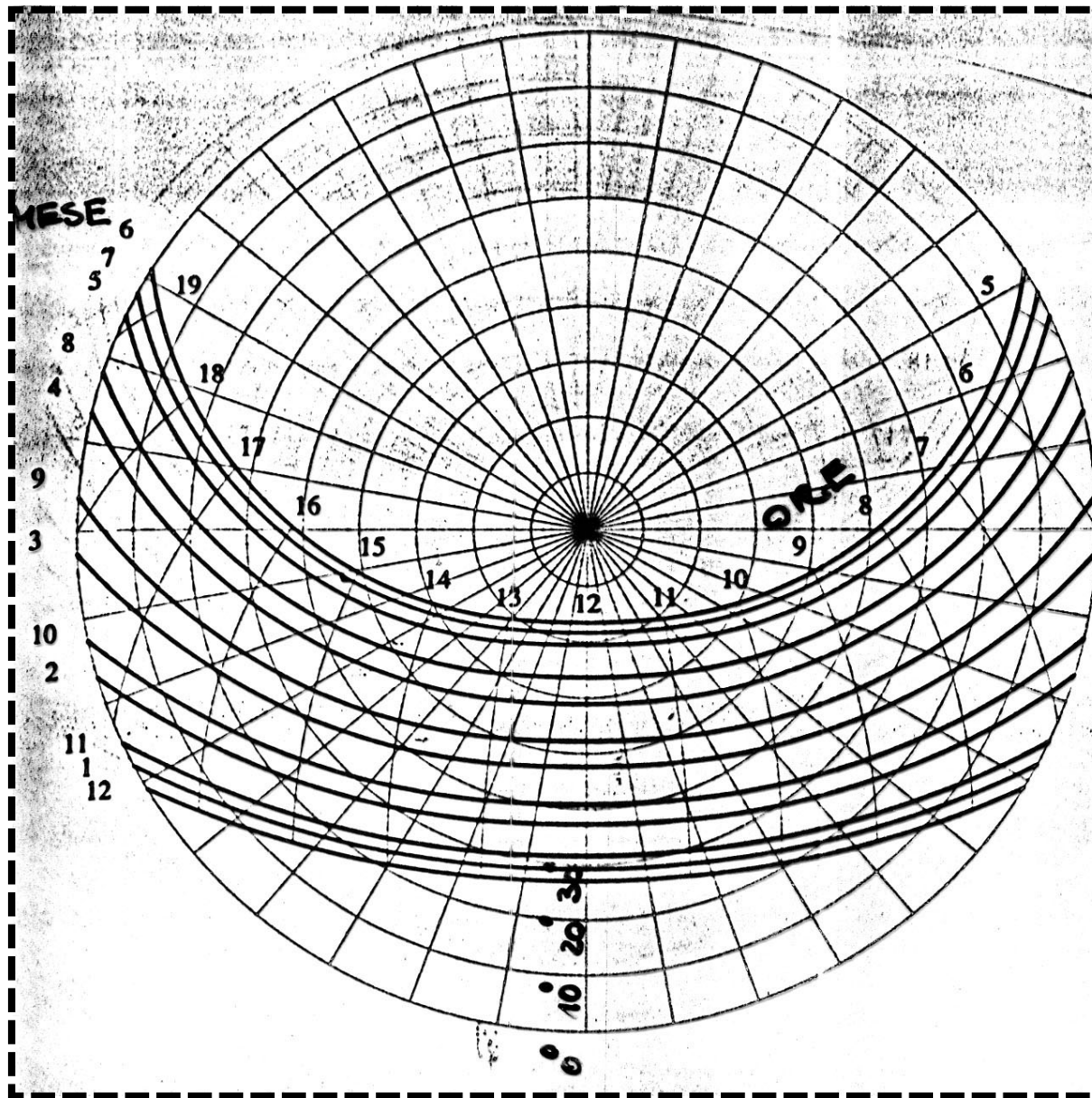
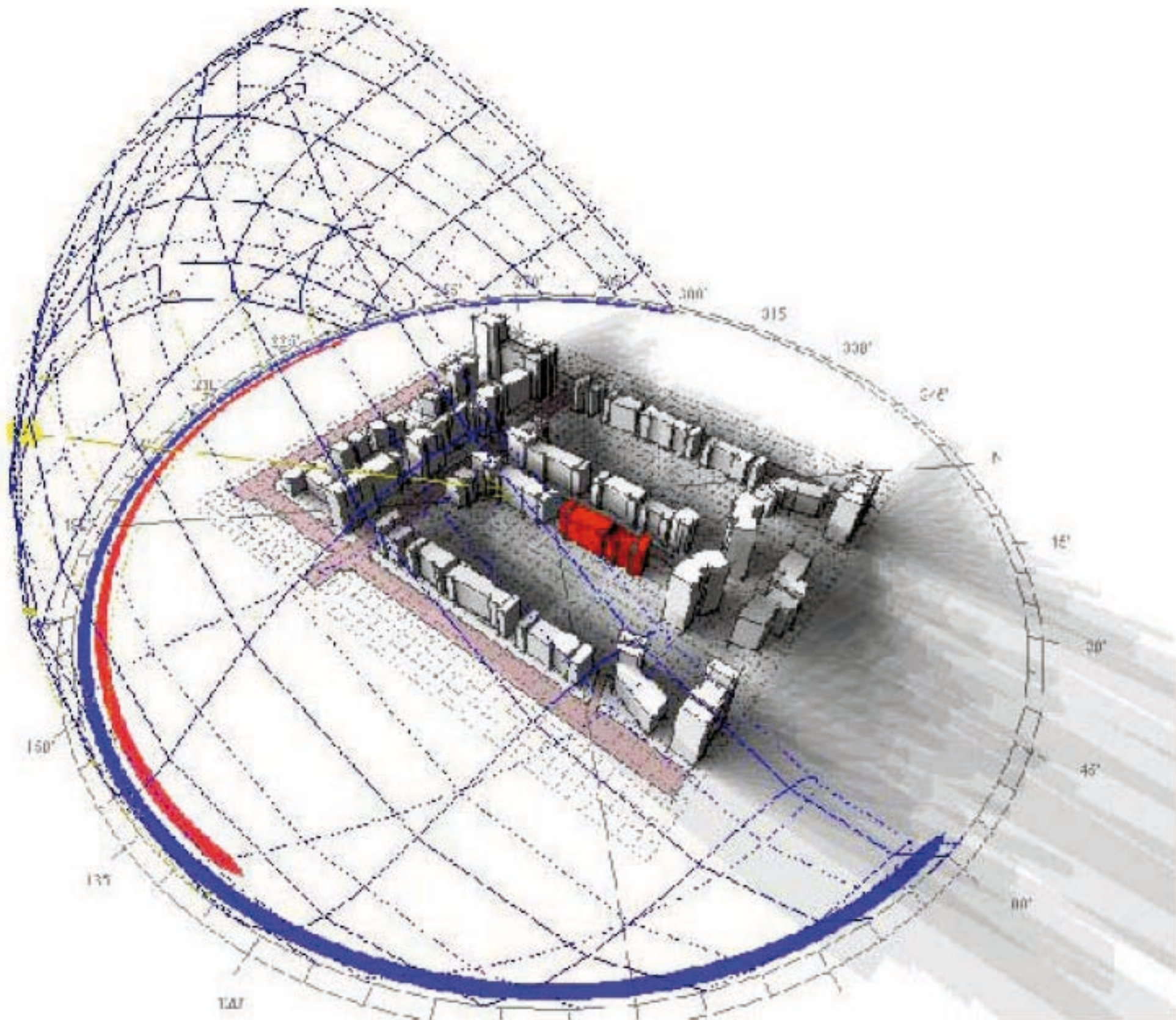

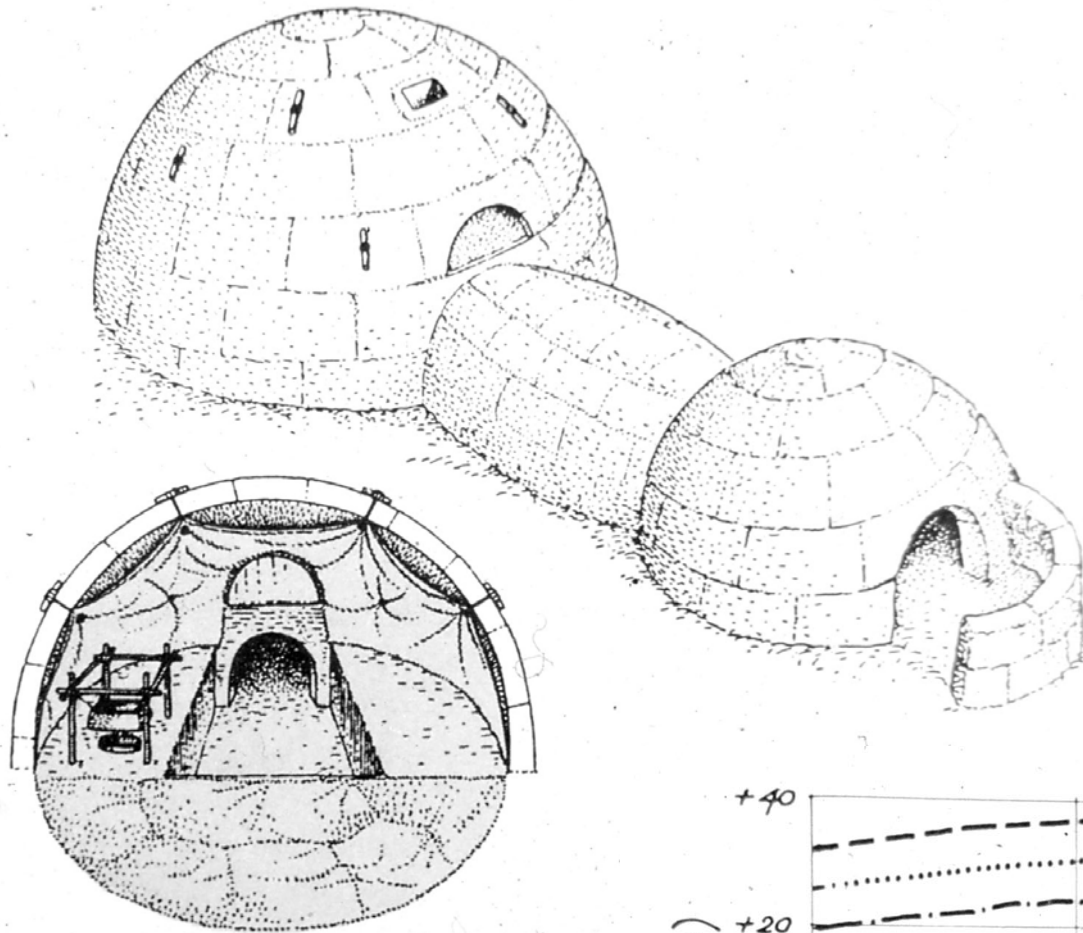

ZONA FREDDA

- >PIANO DI VITA
- >ORIENTAMENTO APERTURE
- >UNICO MATERIALE
- >IRRAGGIAMENTO INTERNO
- >TEMP. OPERANTE

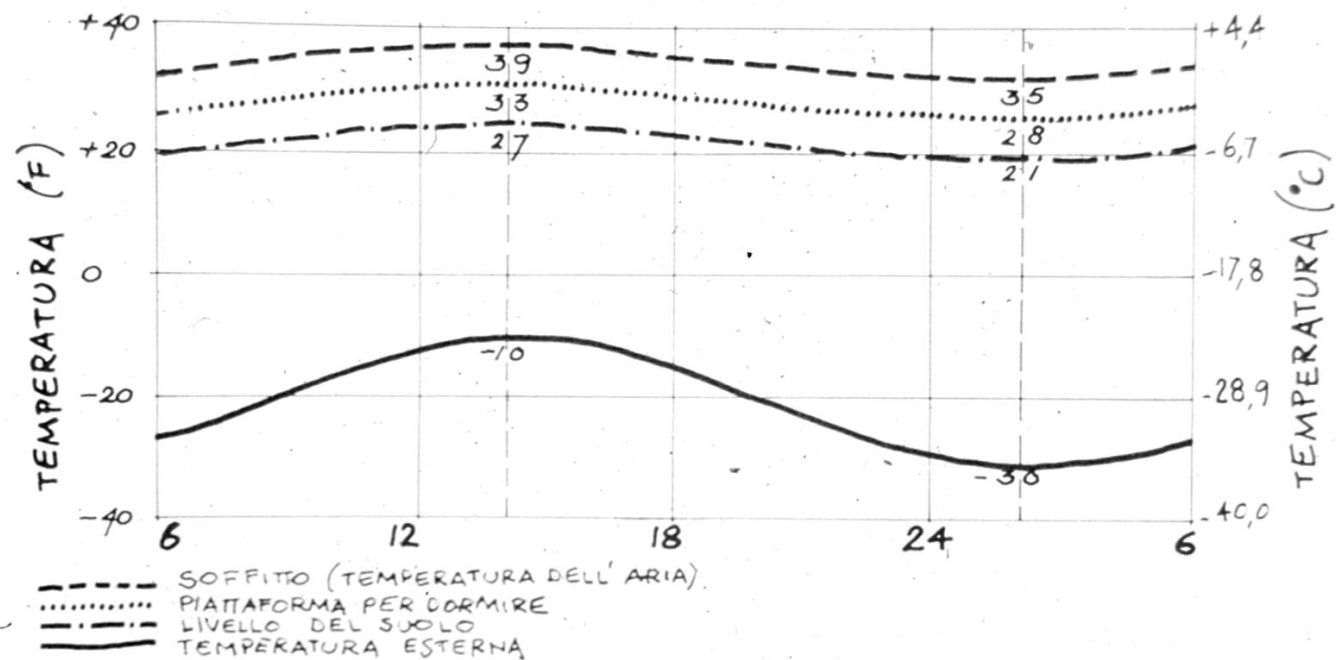

- >MANTENIMENTO DEL PACCHETTO FUNZIONALE
- >CONIUGAZIONE REQUISITI CLIMATICO-AMBIENTALI / MORFOLOGICHE/ FUNZIONALI

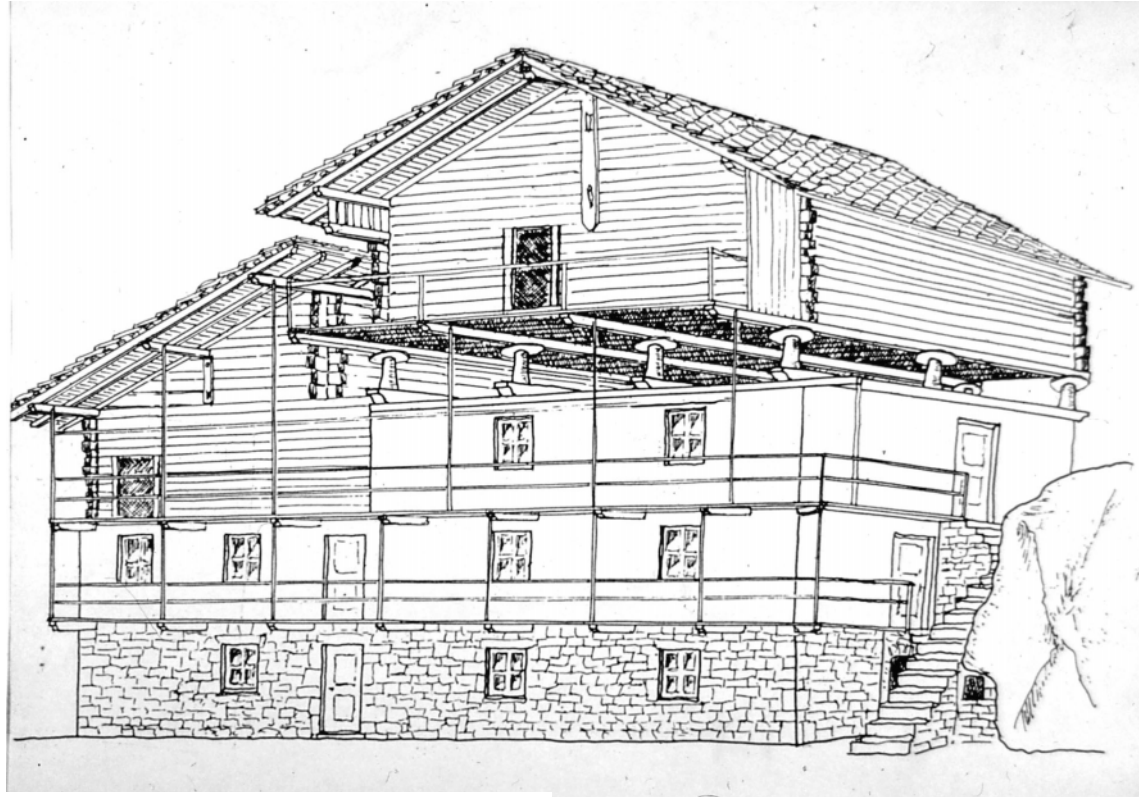

INSEDIAMENTI IPOGEI
>VOLANO TERMICO TERRENO

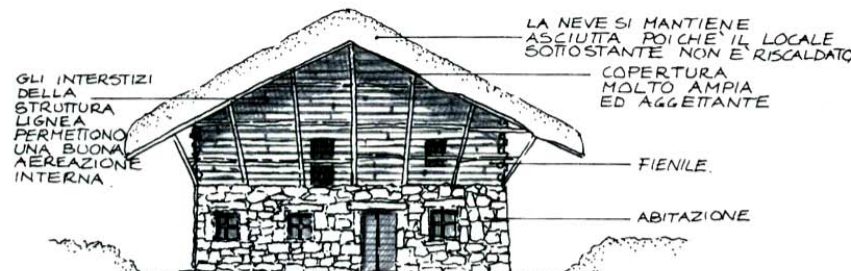
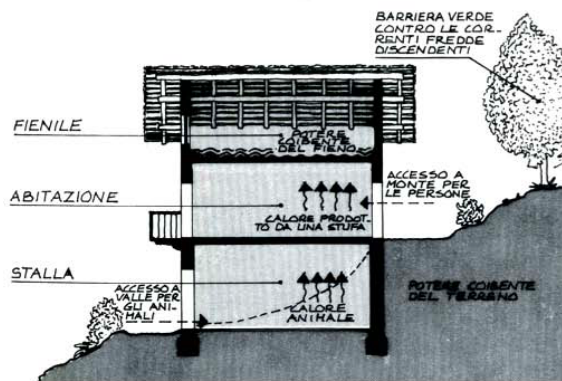
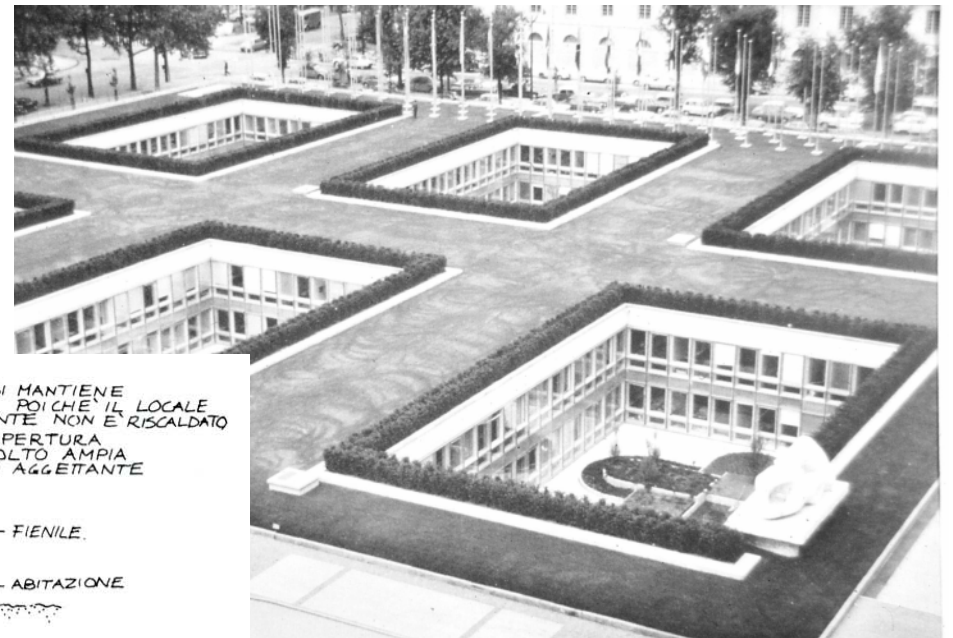



> SINOSSI IPOGEE

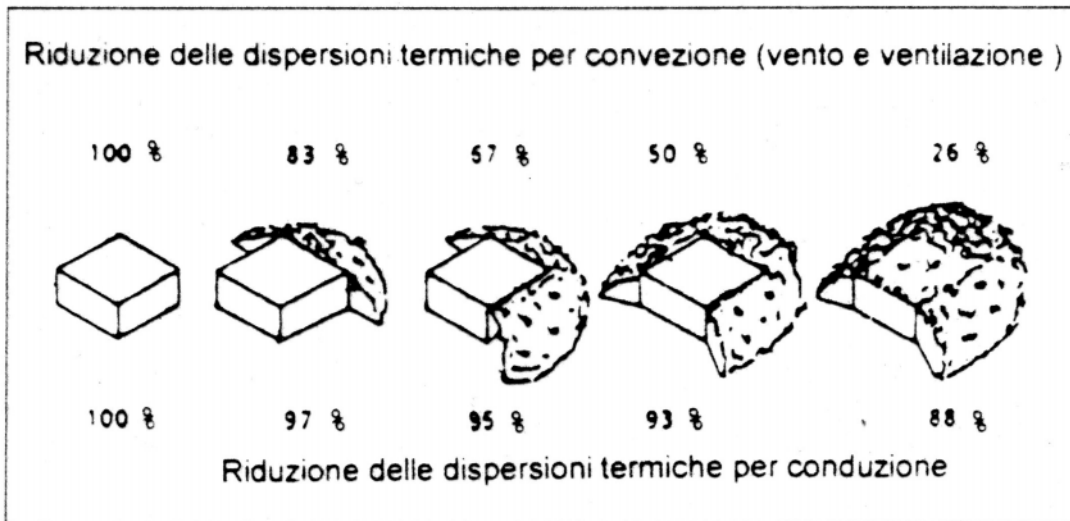
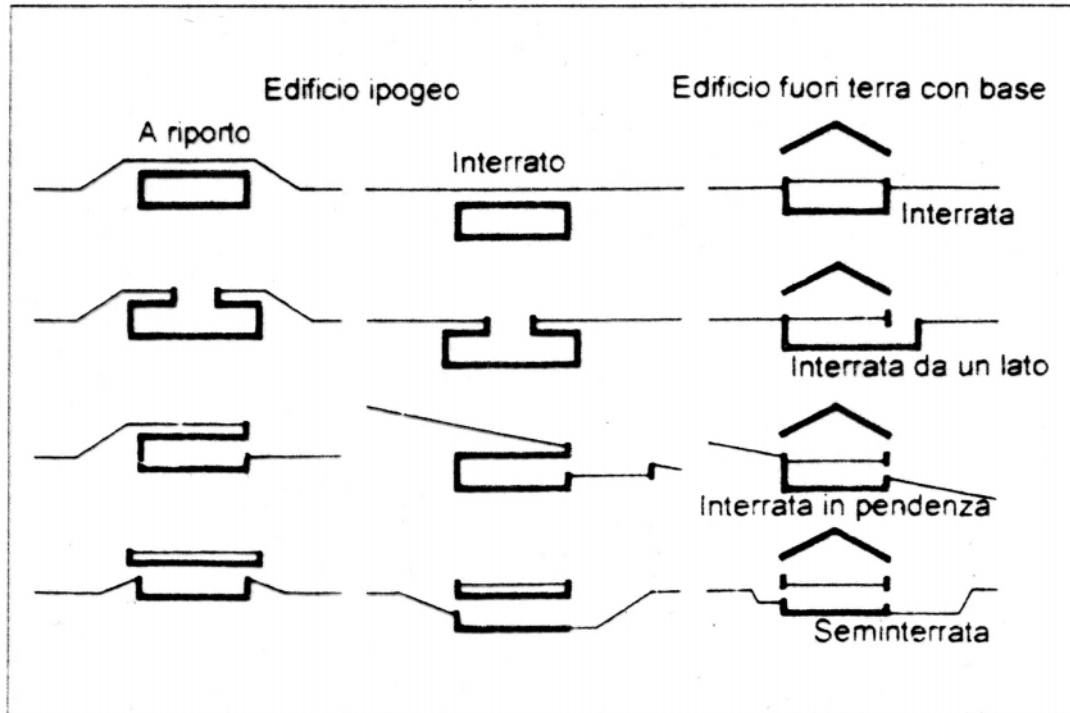

ZONA CALDO SECCA
> PARALLELI



> VOLANO TERMICO IDRICO

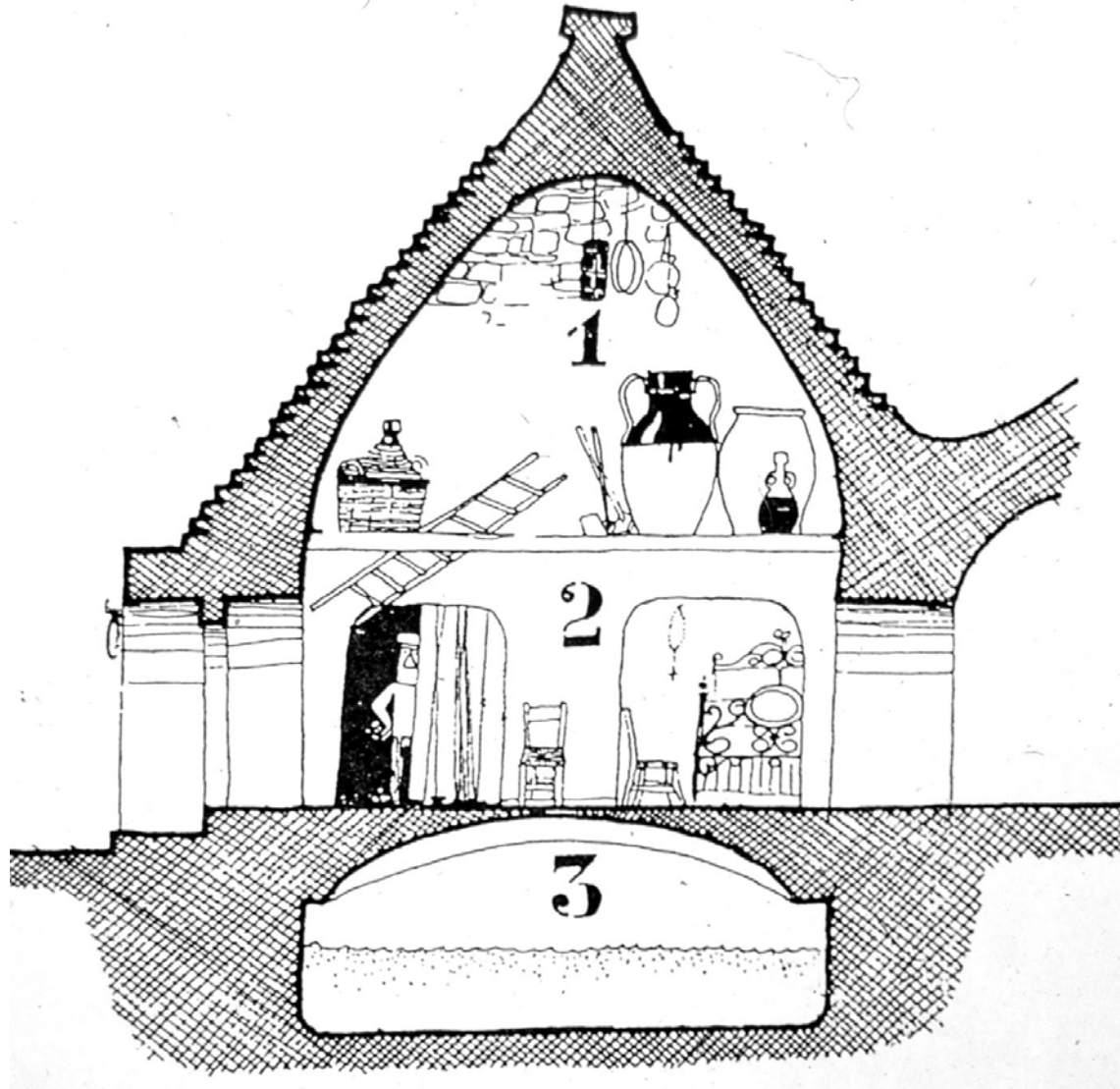

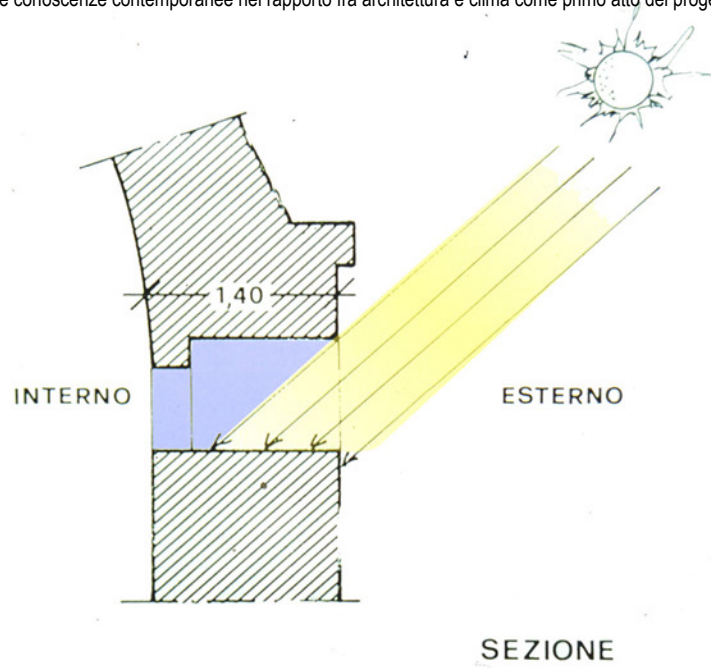
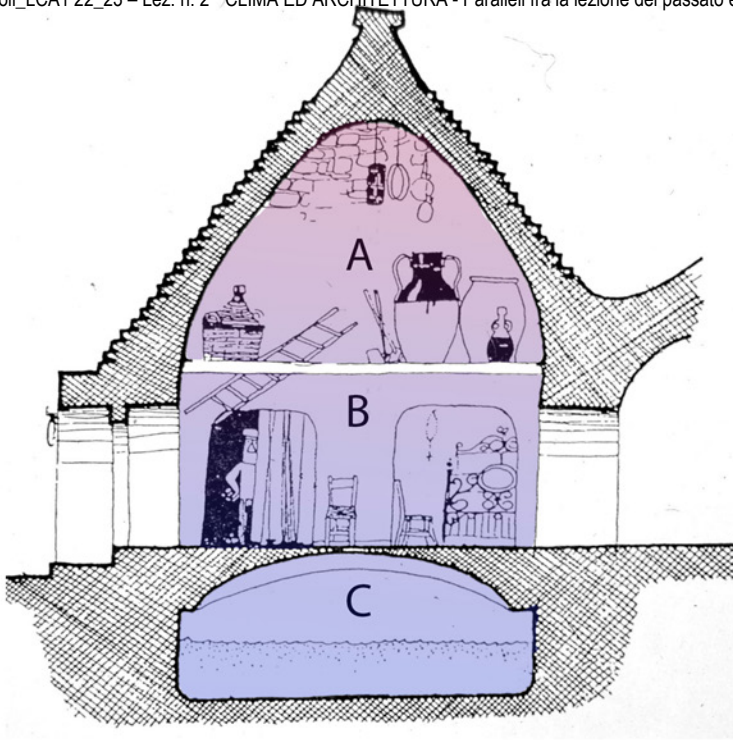

SEZIONE

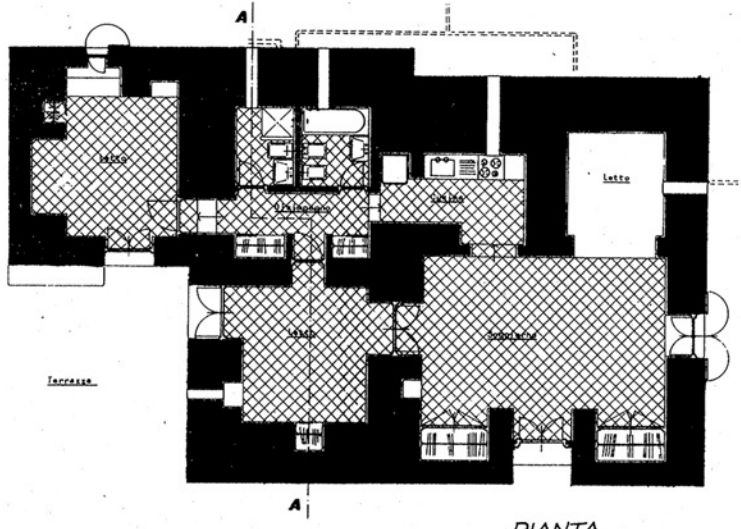

PIANTA

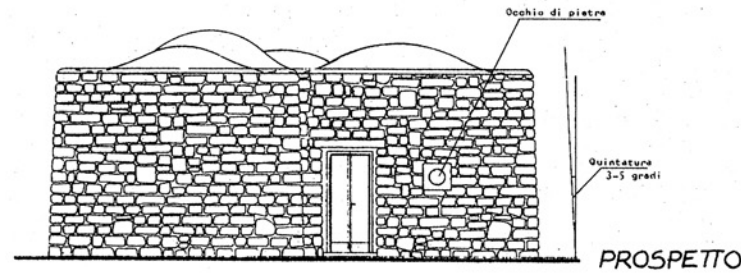

PROSPETTO

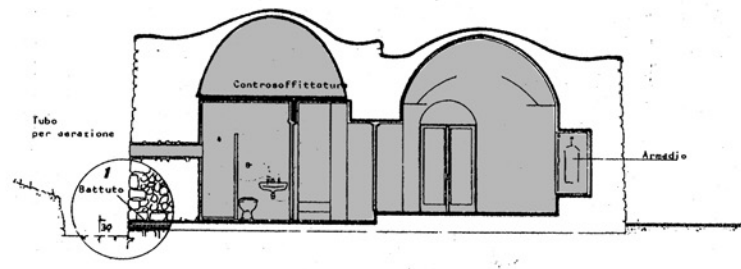

SEZIONE A-A'

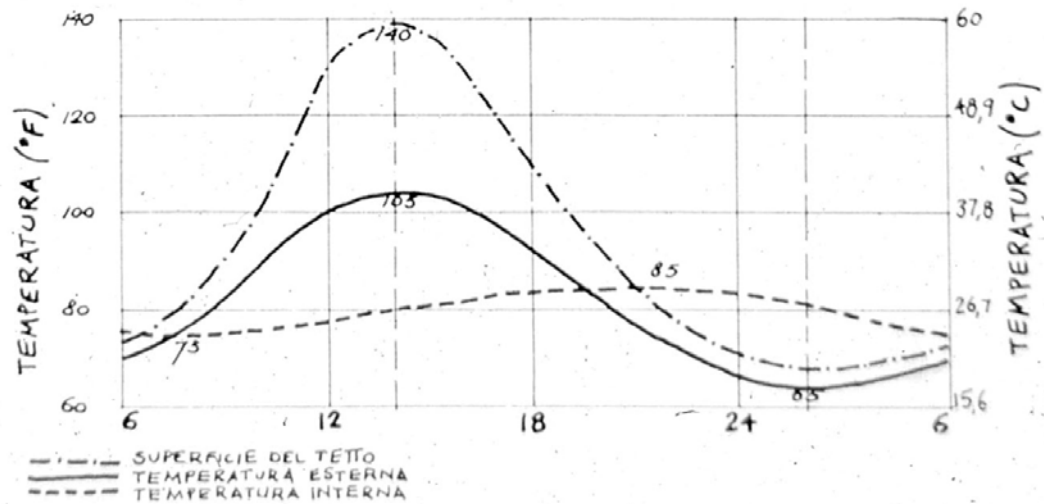
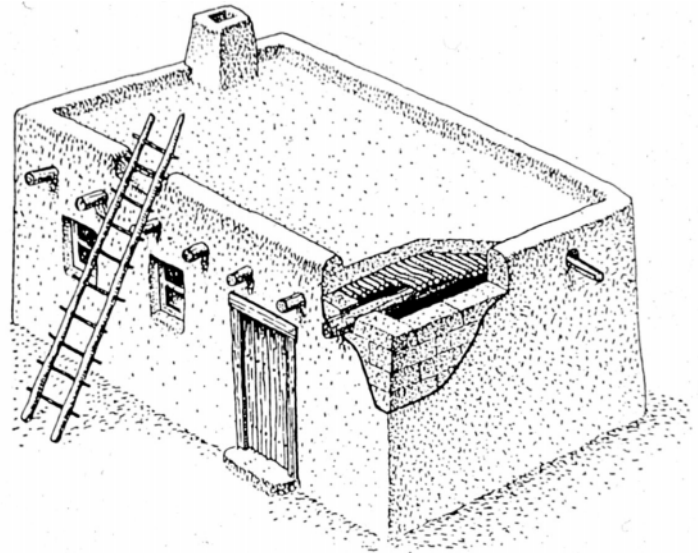

INERZIA TERMICA DELL'INVOLUCRO

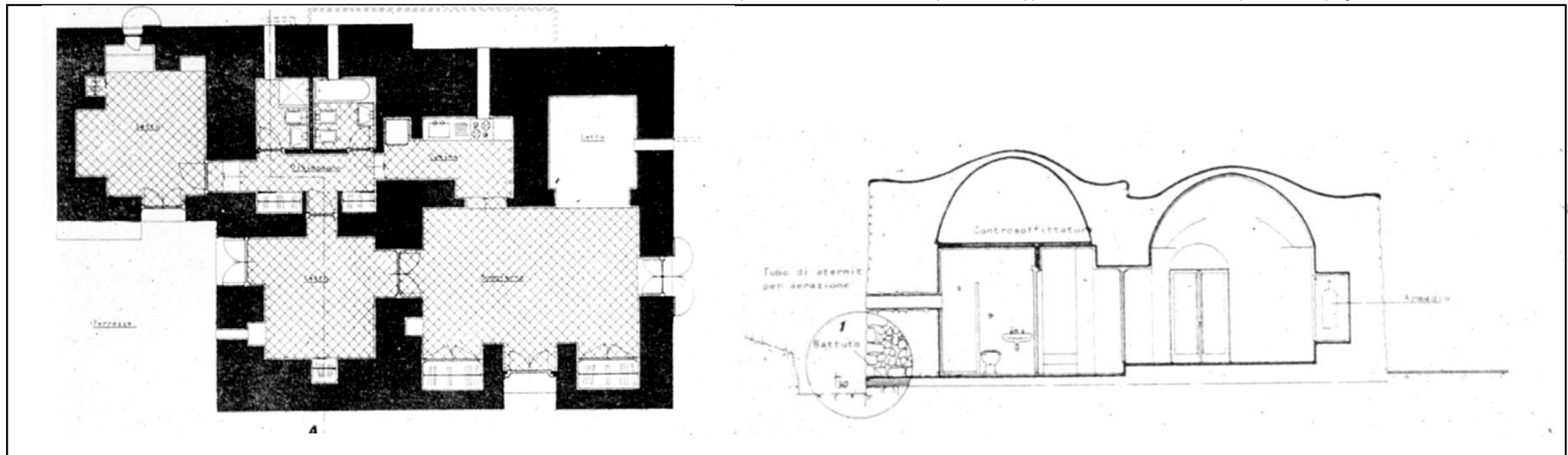

VENTILAZIONE

>INERZIA TERMICA+EFFETTO DISPERDENTE

>SISTEMA INTEGRATO DI VENTILAZIONE

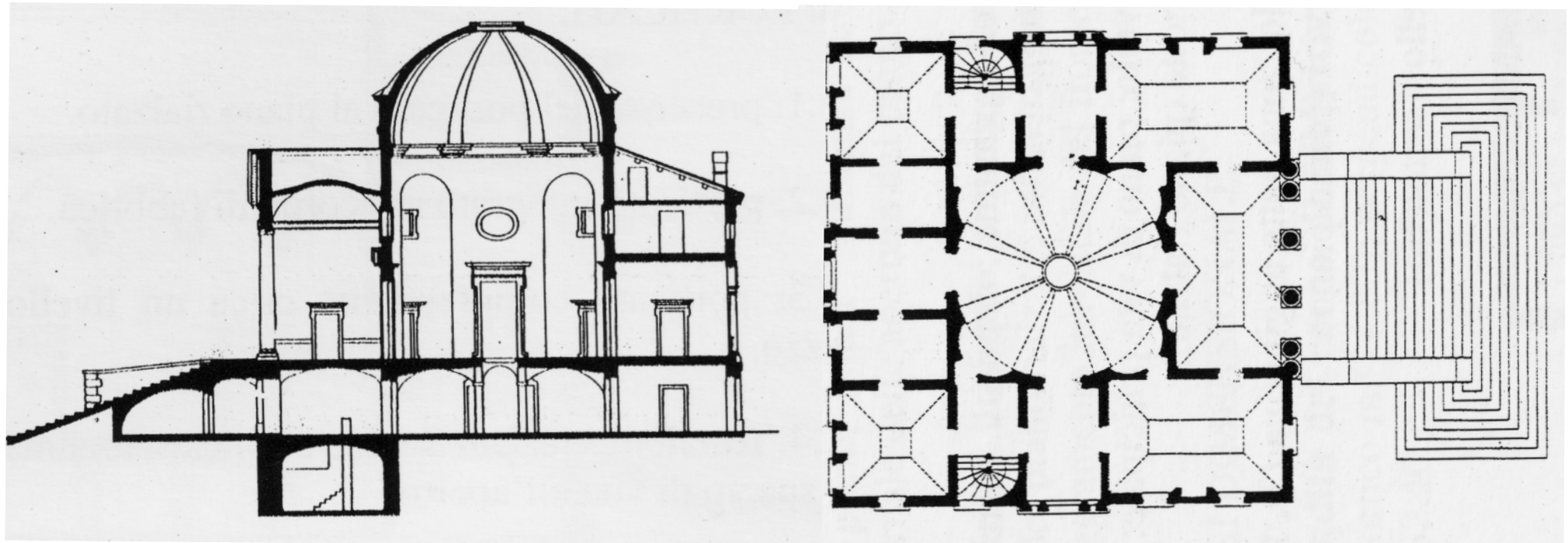

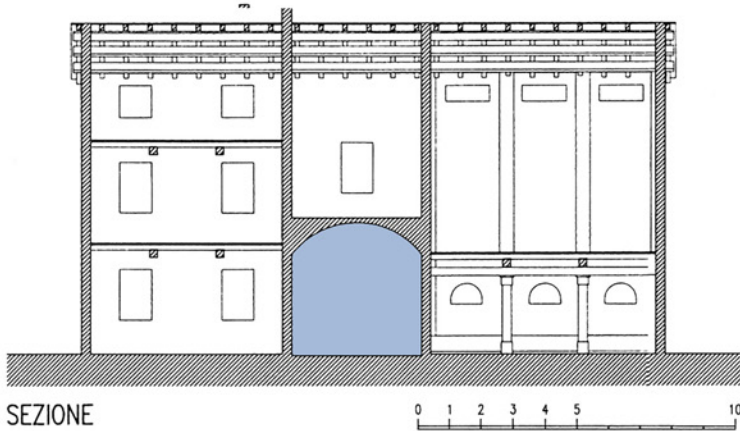
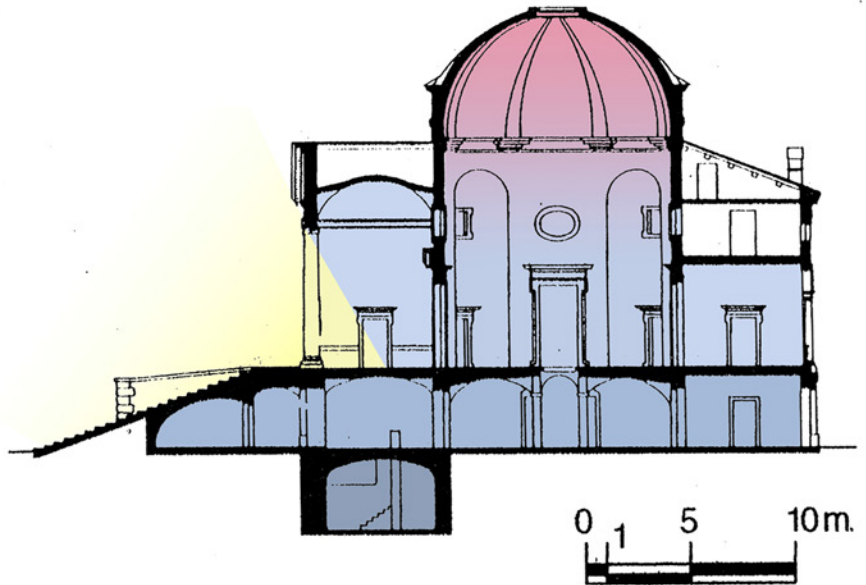
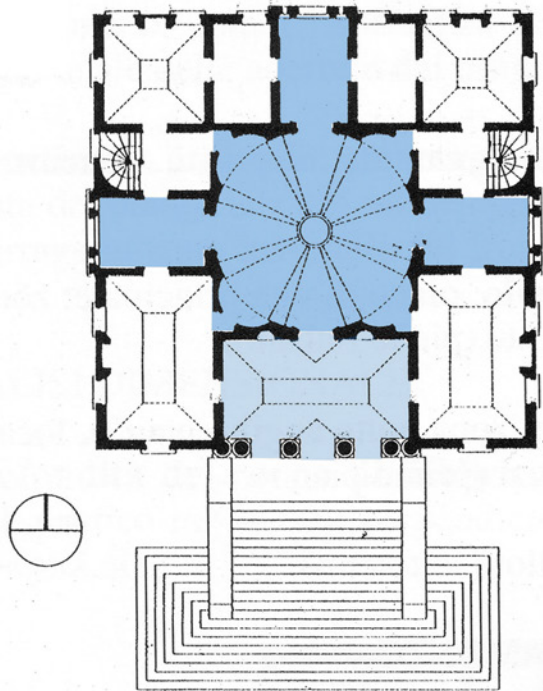

SEZIONE



PIANTA PRIMO LIVELLO

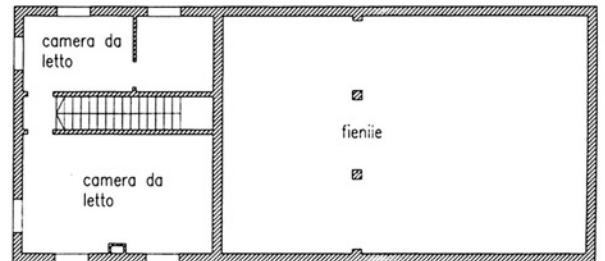

PIANTA SECONDO LIVELLO



>DEPRESSIONE/
SOVRAPRESSIONE

>FRUIZIONE STAGIONALE

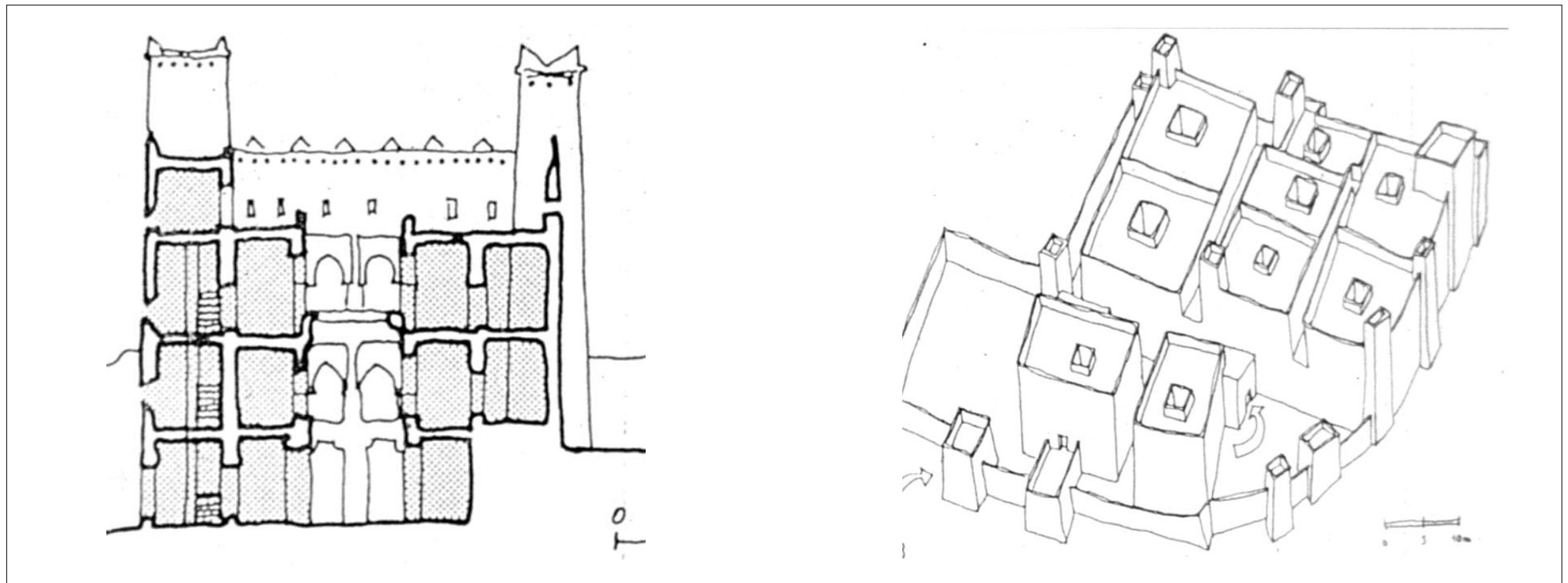
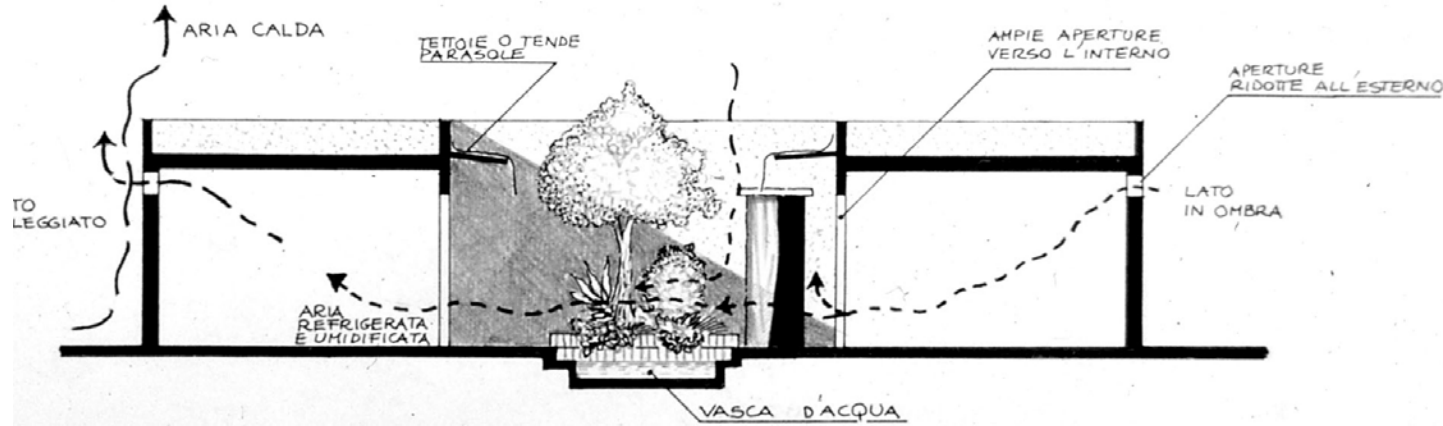



Corte - El Sahan

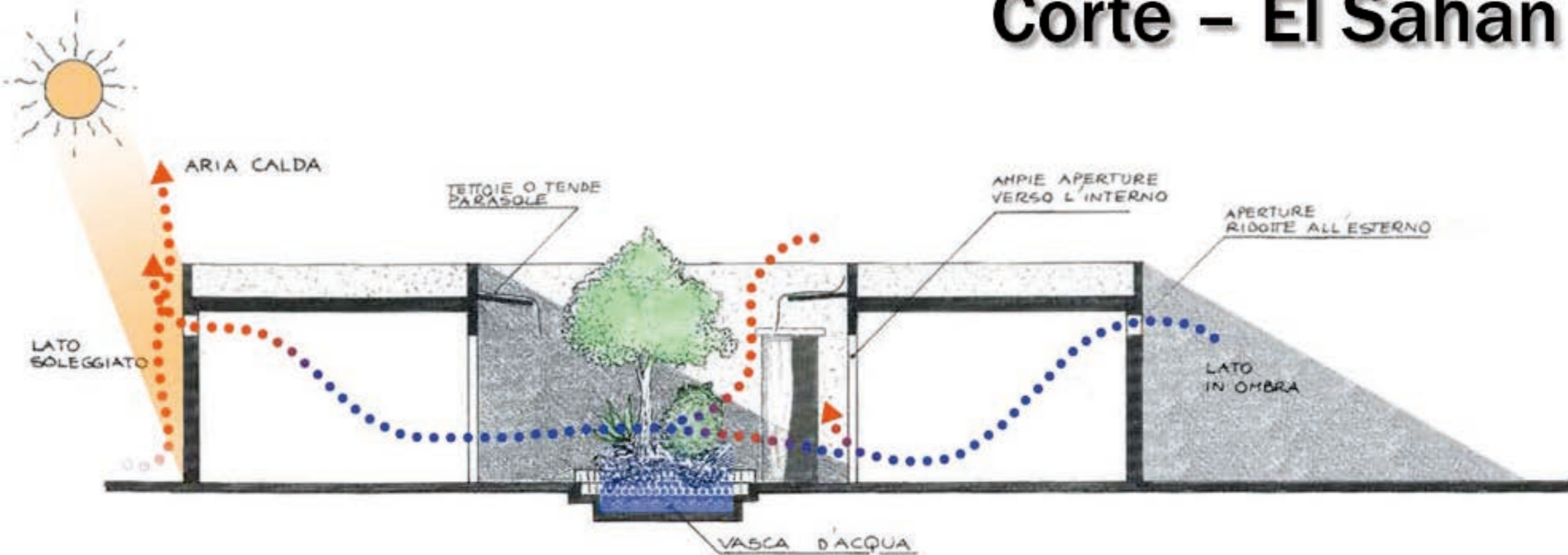

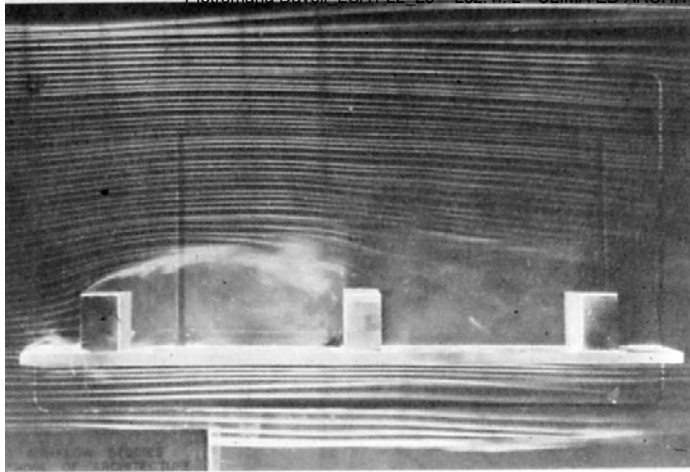

196. Wind shadow effect at parallel rows.

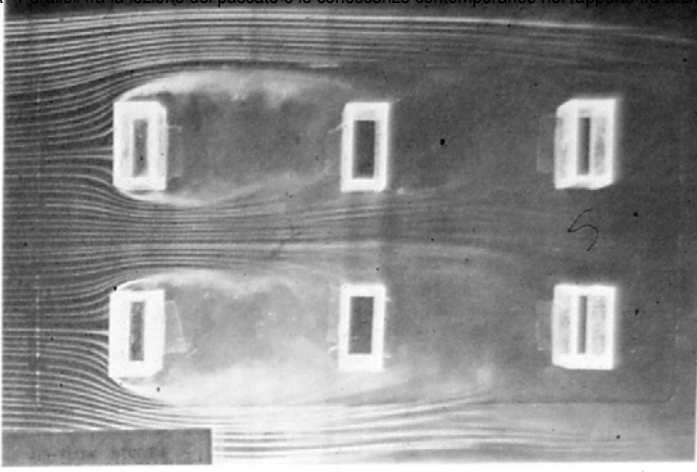

197. Wind protection with linear housing arrangement.

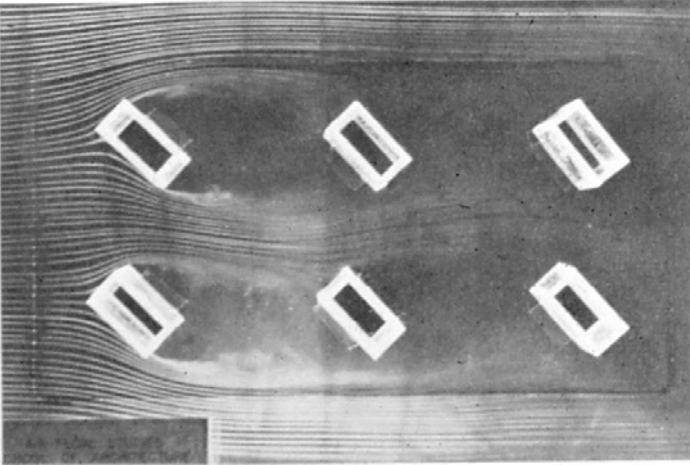

198. Wind protection effect in housing layout.

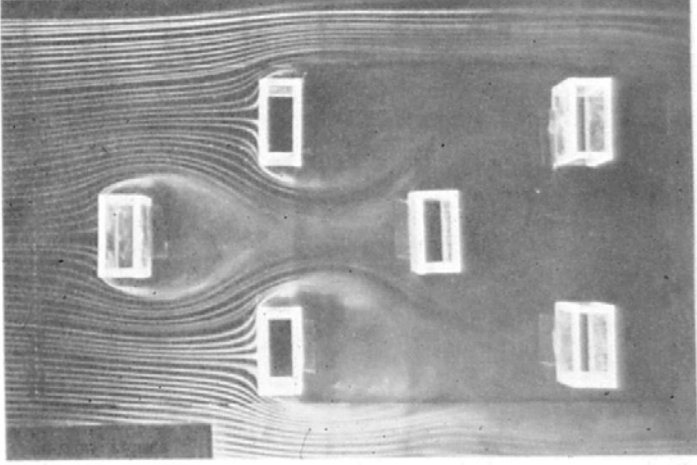

199. Utilization of summer breezes.

FENOMENI EOLICI

- >SFRUTTAMENTO/DIFESA
- >VENTILAZIONE TRASVERSALE

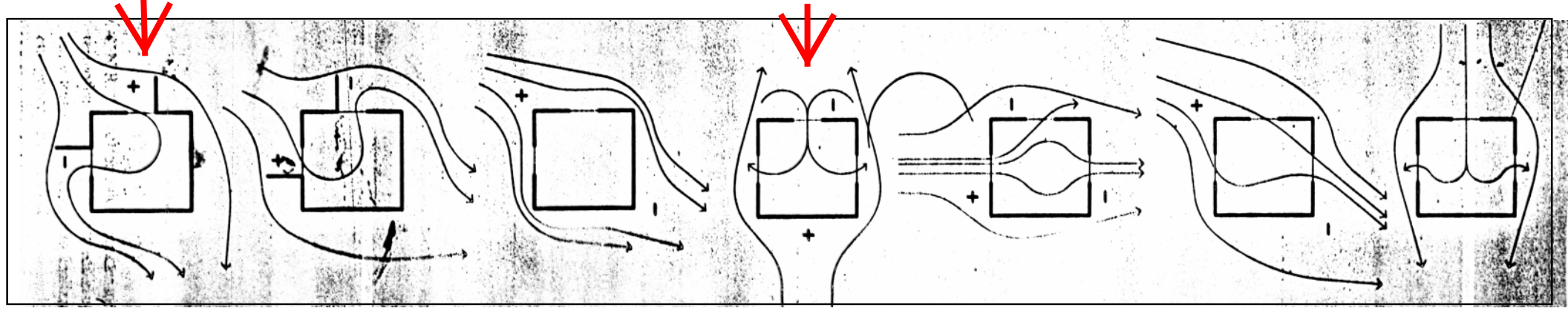
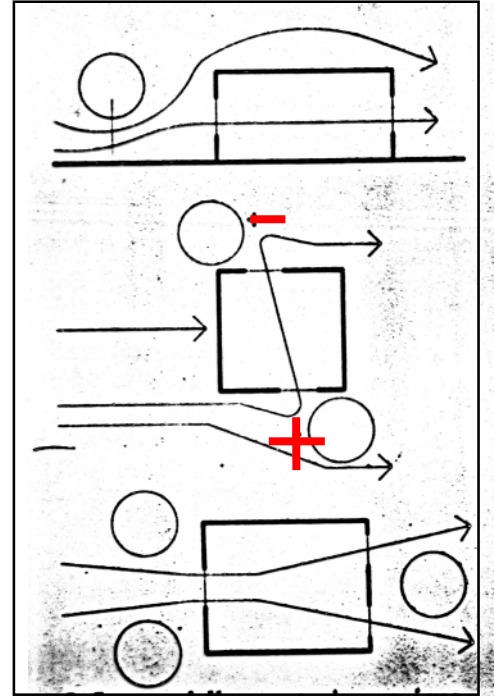

Real-Time Analysis

Begin Airflow Simulation: [Pause]

Analysis: 2D 3D

Velocity (m/s): [Slider] 13,70

Angle: [Slider] 269,0

Display: Wind Velocity (m, ▾)

Detailed Wind Analysis...

Analysis Grid Settings...

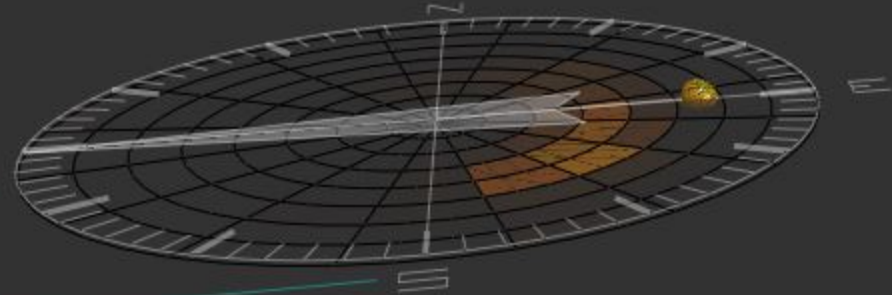
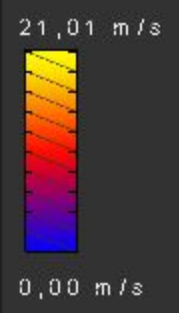

2D Grid Slice

Show 2D Data Slice

Position: [Slider] 73,0

3D Axis: XY (horizontal) ▾

Animate: Cycle ▾ [Play]

Display: Colored Cells ▾

Show Grid Lines

Displace Values in 3D

Amount: [Slider] 0,492

3D Volumetric

Data Display

Model Display

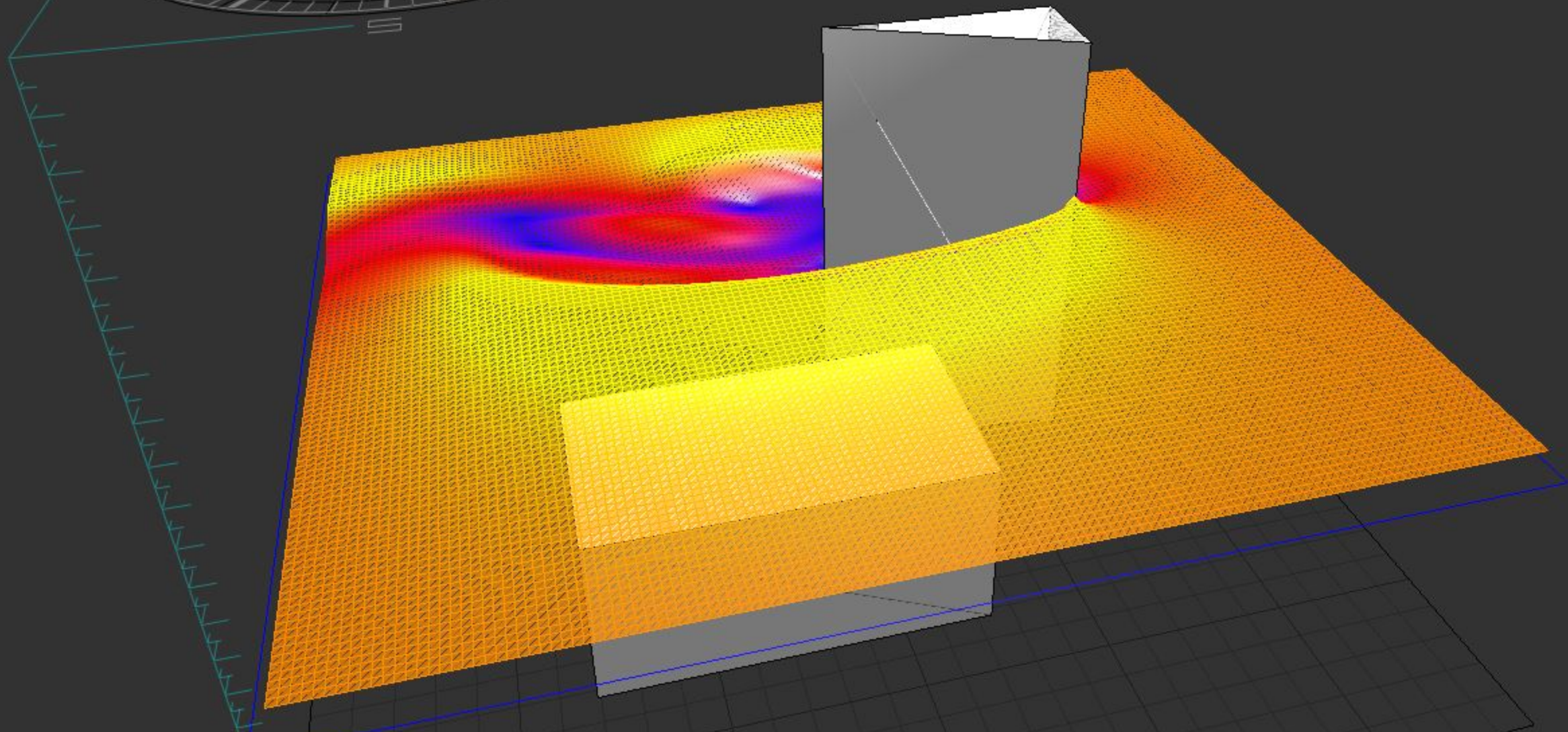

Note: These results are experimental and have not been fully validated.

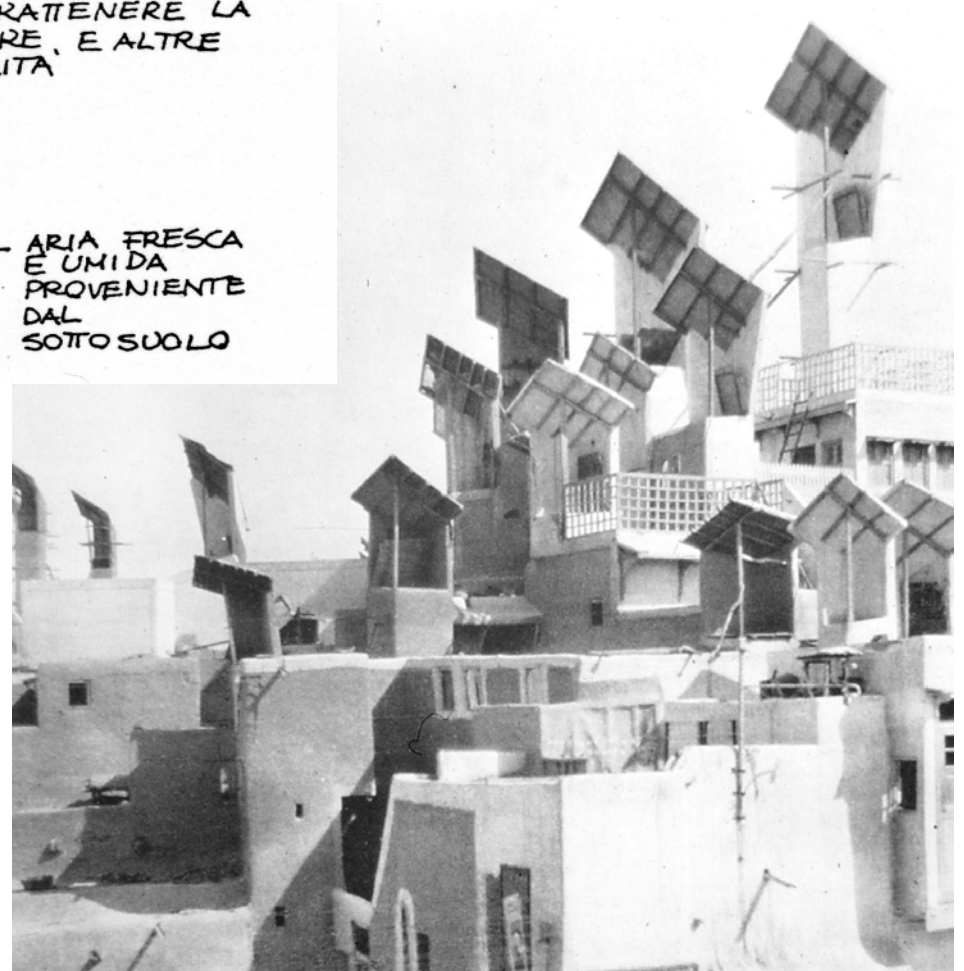
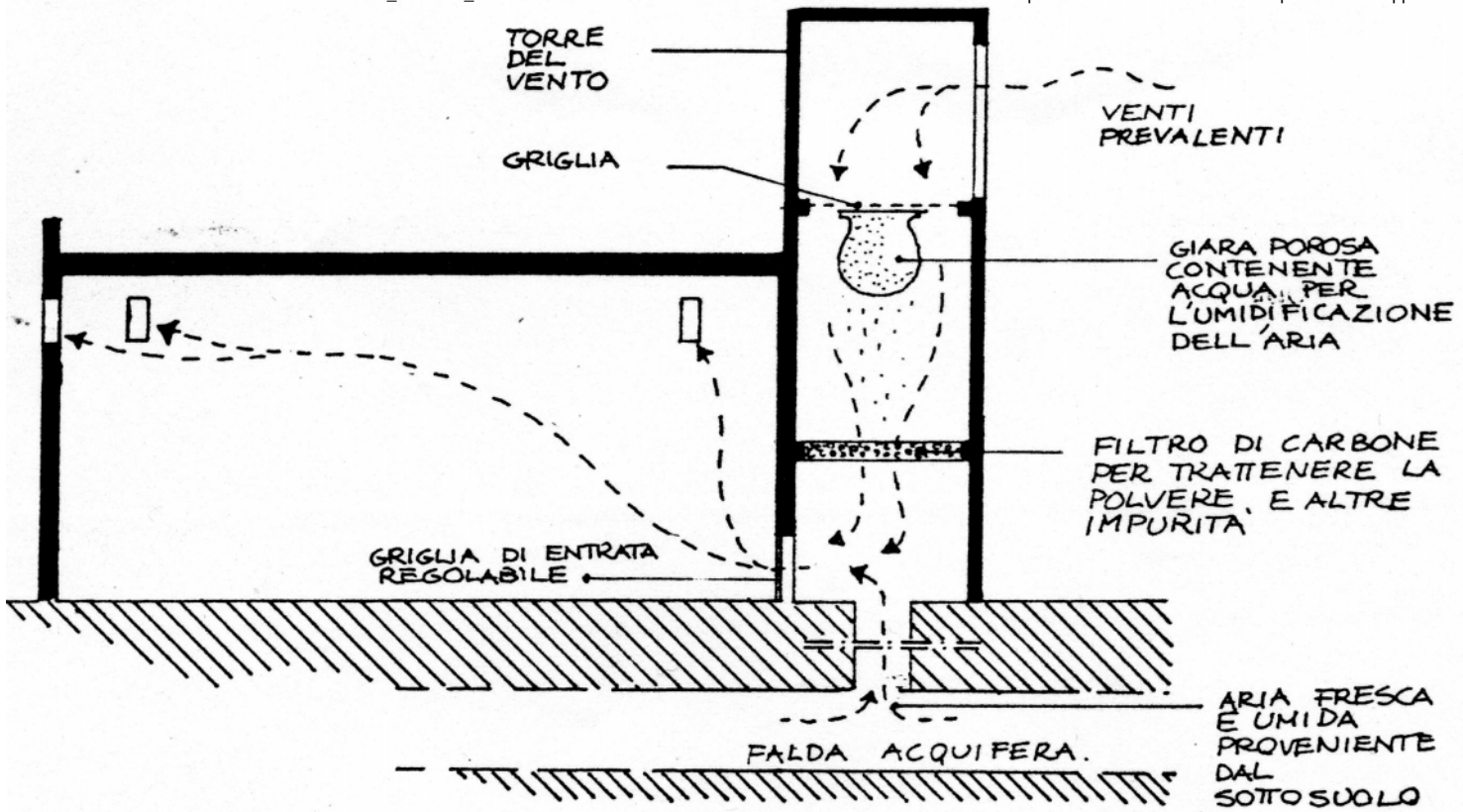

“SISTEMI IMPIANTISTICI” PREINDUSTRIALI

- >BOCCHIE A VENTO
- >TORRI DEL VENTO (TRATTAMENTO)

la torre del vento produce un effetto contrario (moto discendente) rispetto all'effetto "camino solare" (moto ascendente)

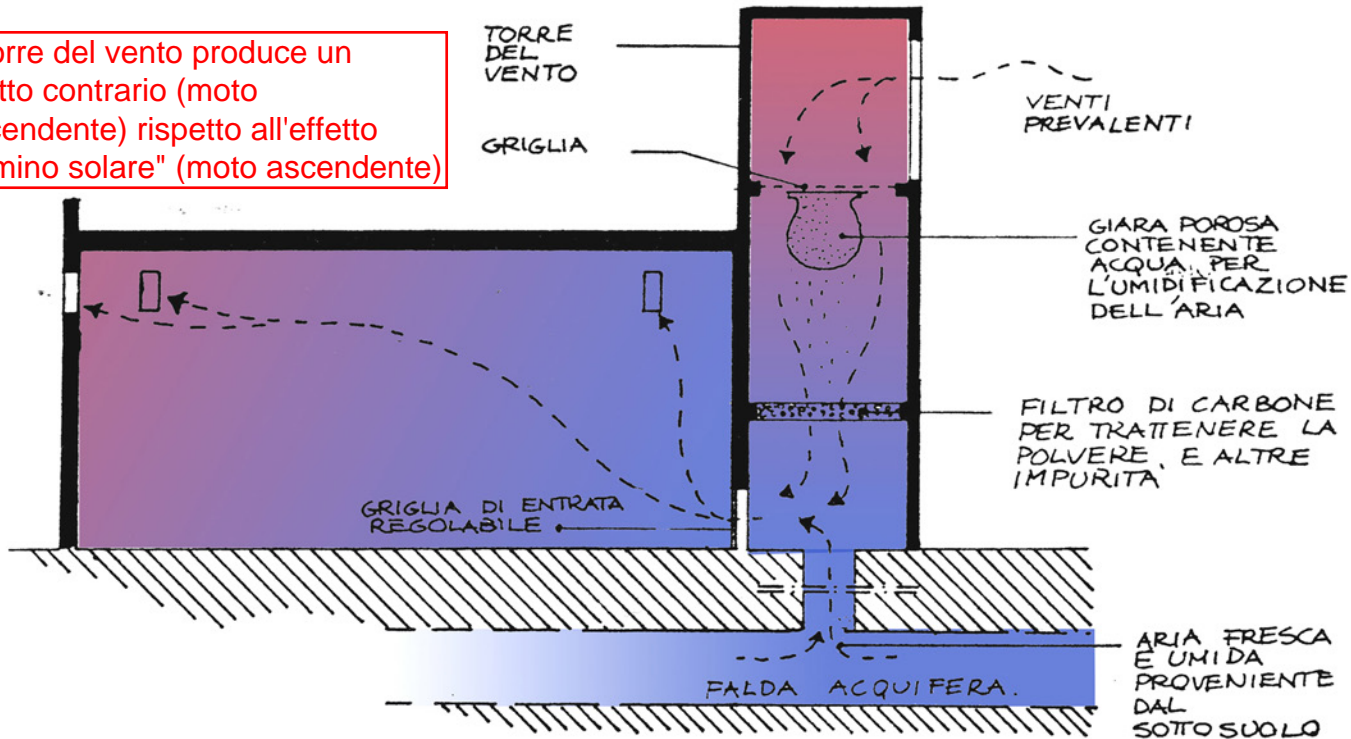

Torri del vento

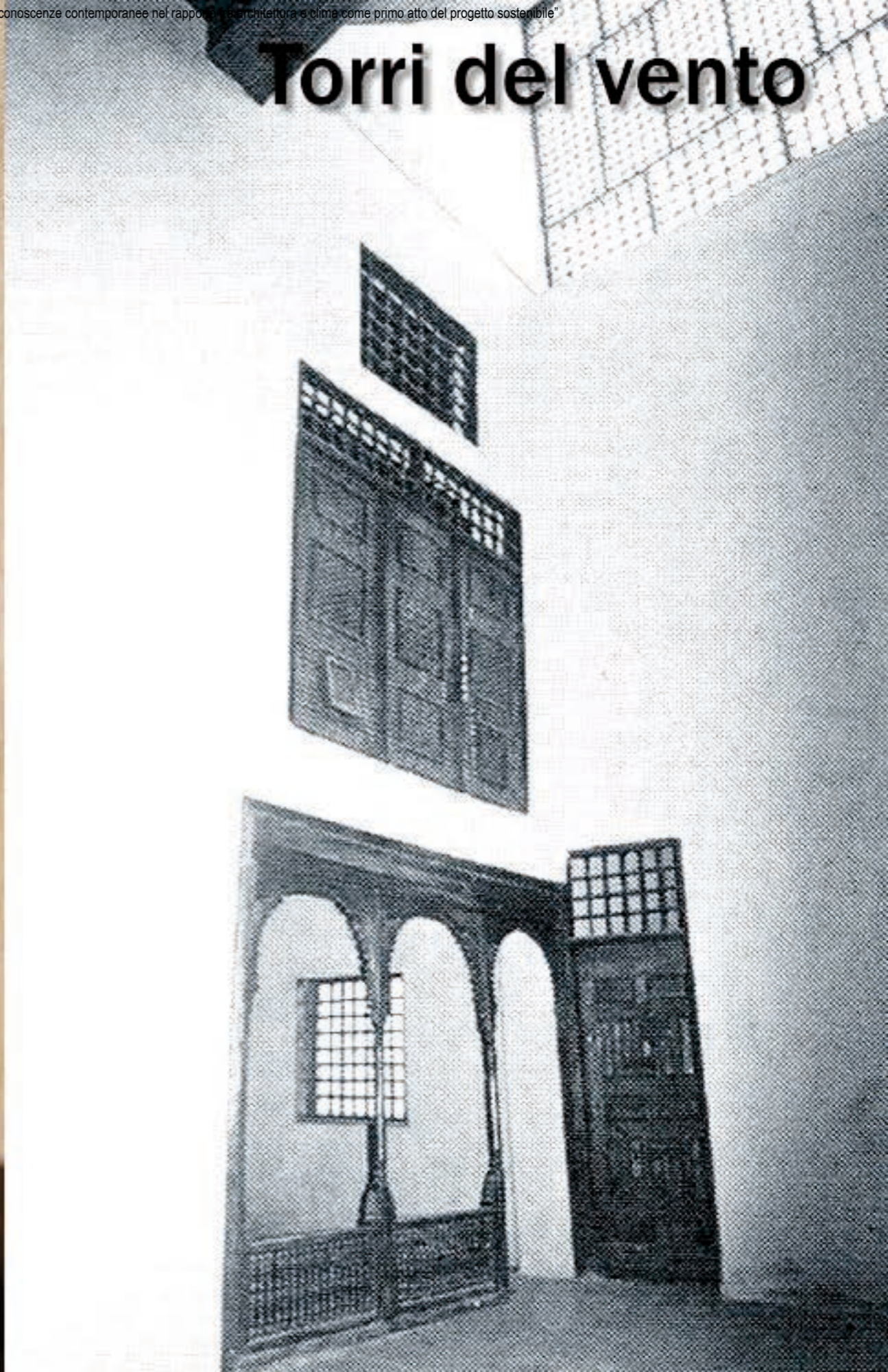

Torri del vento

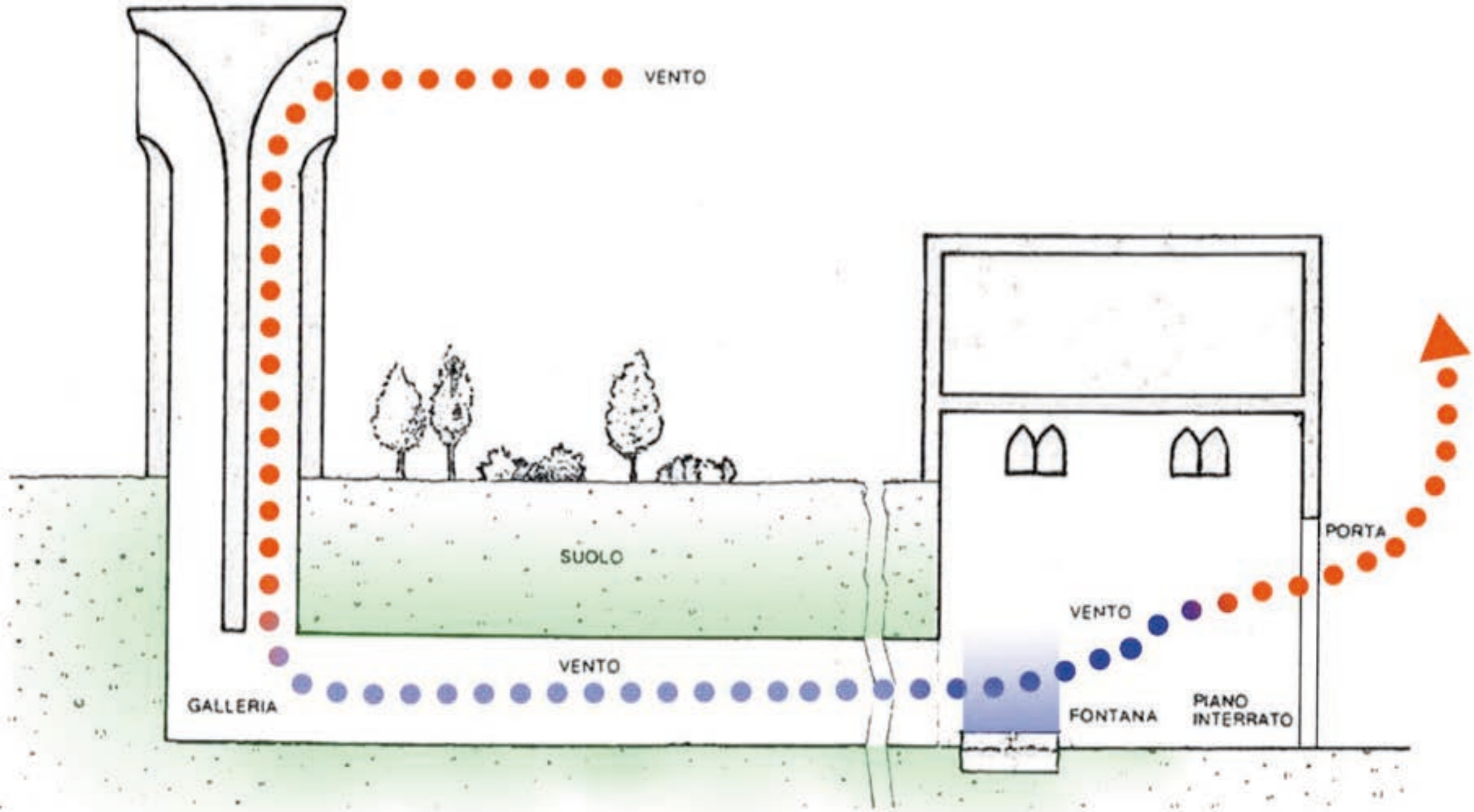



sistema di pre-condizionamento dell'aria, utilizzando condotta ipogea nel giardino

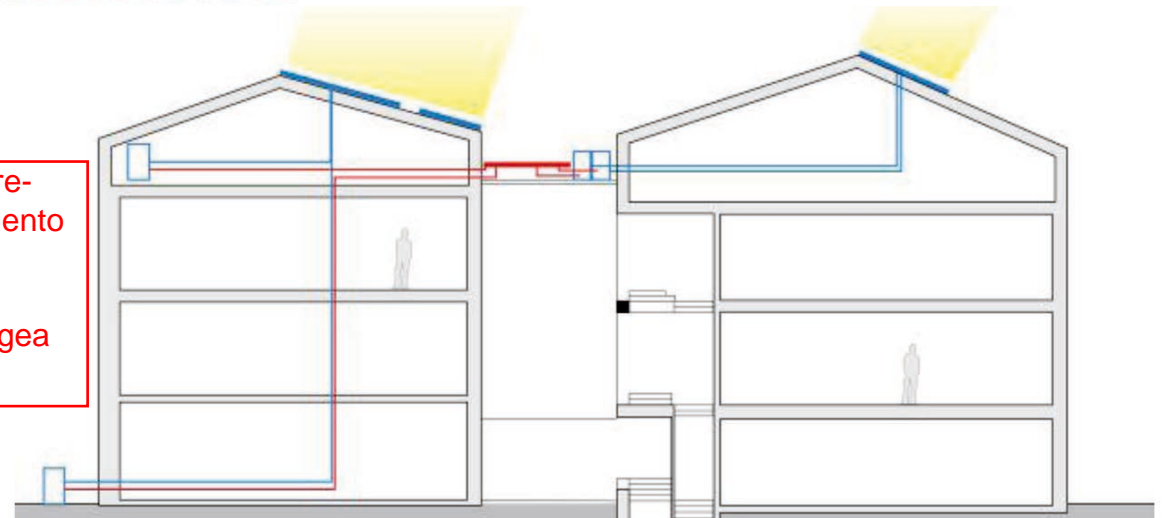

SPAZI INTER-ESTERNI

>DINAMICA SPECULATIVA P.E.

